

A supplement for use with
STAR TREK[®]
THE ROLE PLAYING GAME

Second Edition

2204

SHIP CONSTRUCTION MANUAL

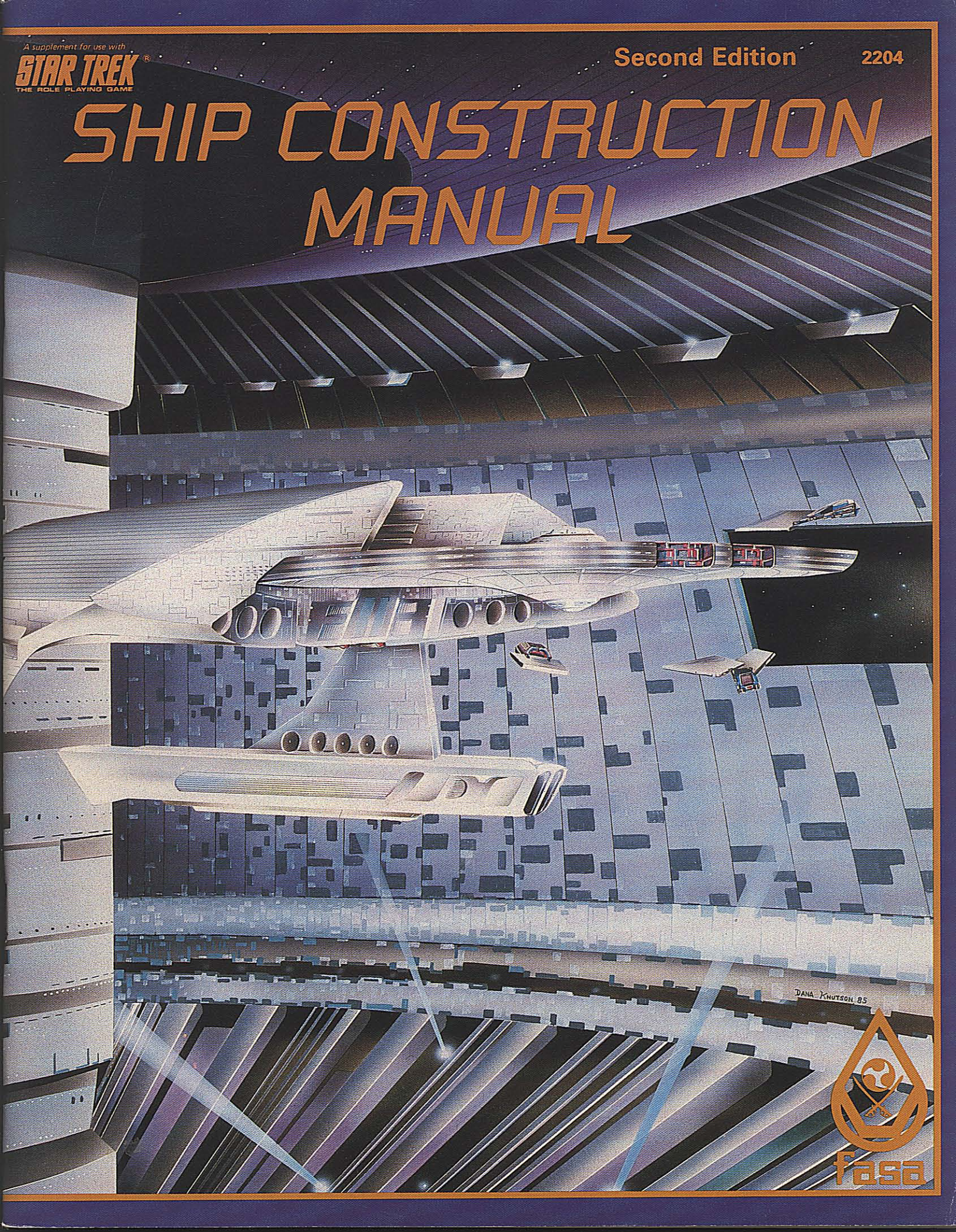

DANA KHUTSON 85



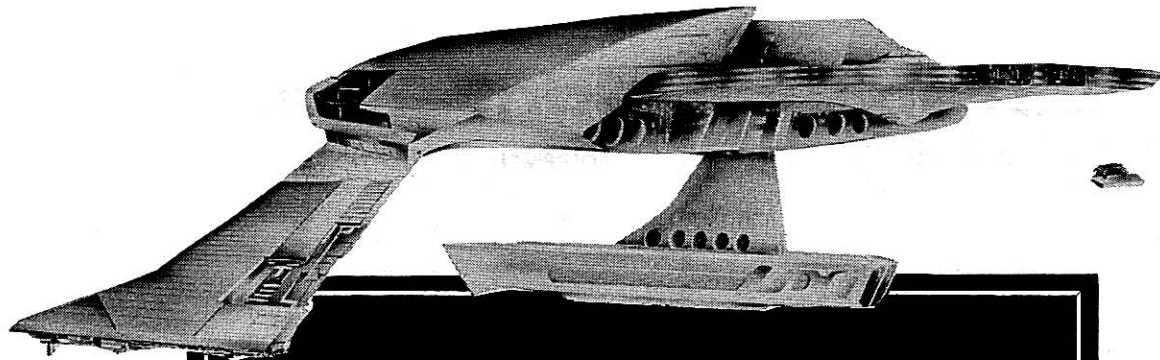

SHIP CONSTRUCTION MANUAL

First Edition Design

David F. Tepoch of *Fantasimulations Associates*

Second Edition Design And Development

Forest G. Brown

Wm. John Wheeler

David F. Tepoch

Ship Construction Table Expansion

Forest G. Brown

Combat Efficiency System

Wm. John Wheeler

Forest G. Brown

Cost, Availability, And Black Market

Greg K. Poehlein

Second Edition Writing

Wm. John Wheeler

David F. Tepoch

Forest G. Brown

Editorial Staff

Editor-In-Chief

L. Ross Babcock III

Editing

Wm. John Wheeler

Proofreading

Forest G. Brown

Donna Ippolito

Production Staff

Graphics Design

Dana Knutson

Illustration

Dana Knutson

Todd Marsh

Mitch O'Connell

Lay-Out And Paste-Up

Dana Knutson

Todd Marsh

Jane Bigos

Typesetting

Karen Vander Mey

Harassment

Jordan K. Weisman

L. Ross Babcock III

STAR TREK is a trademark of Paramount Pictures Corporation and is used under exclusive license by FASA Corporation.

Copyright © 1966, 1985 Paramount Pictures Corporation
All Rights Reserved

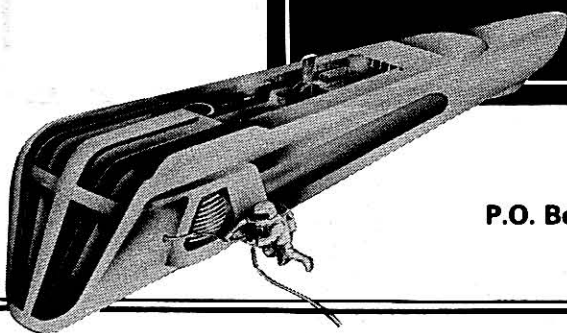

FASA Corporation
P.O. Box 6930 • Chicago, IL 60680-6930

Table Of Contents

INTRODUCTION TO WARSHIP DESIGN	3	EQUIPMENT DESCRIPTIONS	20
Contents Of This Book	3	Control And Guidance Systems	20
Construction Table Terms	3	Propulsion And Power Systems	21
CONSTRUCTING	6	Deflector Shield Systems	24
Narrow The Field	6	Weapon Systems	26
Select Equipment	6	Superstructure And Support Systems	28
<i>The Ship Construction Form</i>	6	Ship Construction Facilities	29
<i>Construction Steps</i>	6	AVAILABILITY AND COST	30
Make Limiting Decisions	6	Construction Costs	30
<i>Decide Ship Class</i>	6	Calculating Total Cost	30
<i>Choose Control Computer Type</i>	6	<i>Estimated Base Cost</i>	30
Choose Warp Engine Type	7	<i>Tonnage Modifier</i>	30
<i>Select Engine Type And MPR</i>	7	<i>Total Cost</i>	30
<i>Record Engine Stats</i>	7	Component Availability	30
Choose Impulse Engine Type	7	Legality Codes	30
<i>Select Engine Type</i>	7	Availability Codes	31
<i>Record Engine Stats</i>	7	WARSHIP DESIGN MANUAL	32
<i>Calculate Total Power Available</i>	7	Design Philosophy	32
Choose Shield Generator Type	7	Star Fleet	32
<i>Select Generator</i>	7	Klingon Imperial Navy	32
<i>Record Shield Stats</i>	8	Romulan Imperial Navy	33
Choose Weapon Types	8	Gorn Navy	33
<i>Select Weapons</i>	8	Orions	33
<i>Record Weapon Stats</i>	8	Design Requirements Checklist	33
<i>Calculate Total Weapon Mass</i>	8	GAMEMASTERING SHIP CONSTRUCTION	35
<i>Calculate Weapon Superstructure Strength</i>	8	Designing The Ship	35
<i>Calculate Total WDF</i>	8	Locating Equipment	35
Determine Superstructure Strength	8	Legality	35
<i>Calculate Total SS Requirement</i>	8	<i>Legality Code</i>	35
<i>Determine Superstructure Strength</i>	8	<i>Restricted Sale, Ownership, And Use</i>	35
<i>Calculate SS Mass</i>	8	Availability	35
Check Total Mass	8	<i>Availability Code</i>	35
<i>Calculate Total Mass</i>	8	<i>Modifiers For Attributes And Skills</i>	35
<i>Compare Mass</i>	8	<i>Modifiers For Location</i>	35
<i>Adjust Mass</i>	8	<i>Availability Rolls</i>	36
Calculate Combat Efficiency	8	Determining Construction Costs	37
<i>Calculate Defense Factor</i>	8	Estimating Base Costs	37
<i>Calculate CE</i>	8	<i>Estimated Base Component Cost</i>	37
SHIP CONSTRUCTION FORM	9	<i>Estimated Hull Cost</i>	37
COMBAT EFFICIENCY	10	<i>Total Base Cost</i>	37
Combat Efficiency Formula	10	Design Cost	37
Using The Formula	10	Purchasing Equipment	37
Finding The Defense Factor	10	<i>Black Market Price</i>	38
<i>Power Efficiency</i>	10	<i>Purchase Negotiations</i>	38
<i>Superstructure Strength</i>	10	Do-It-Yourself Ship Construction	38
<i>Defense Factor</i>	10	Actual Cost	38
Finding The Combat Efficiency	10	<i>Actual Ship Cost</i>	38
<i>Using Combat Efficiencies</i>	11	<i>Cost Overruns</i>	38
Origin Of The CE Formula	11	SHIP CONSTRUCTION TABLES	39
<i>Power Efficiency</i>	11	United Federation Of Planets	40
<i>Superstructure Strength</i>	11	Klingon Empire	48
<i>Weapon Damage Factor</i>	11	Romulan Star Empire	56
SHIP CONSTRUCTION GLOSSARY	12	Orion Colonies	66
Evaluation And Design Terms	12	Gorn Alliance	70
Shipboard Areas	14		
Combat Ship Types	18		
Commercial And Non-Combat Vessel Types	19		

Introduction To Warship Design

This supplement for **STAR TREK: The Role Playing Game** presents the statistics and game data for the warp engines, the impulse engines, the ships' computers, the shields, the hulls, the weapons, and the superstructure requirements for the starships of the **STAR TREK** universe. The system presented here will allow players and gamemasters to design their own ships for the UFP, the Klingon Empire, the Romulan Star Empire, the Gorn Alliance, and the Orion Colonies.

This book represents a major redesign of the tables from the first edition. Much new information has been added to the tables, and the original design system has been streamlined and simplified. At the time the first edition of these tables was published, **The STAR TREK III Starship Combat Role Playing Game** had not yet been published, and so they naturally were not organized to make construction for that supplement easy. This edition restructures and reformats the data, adding new information to make ship construction a logical extension of all the rules and supplements that have already been printed for **STAR TREK** starships.

In this book, Starship Tactics gamers will find a system for comparing the Combat Efficiency of all starships, from the impressive *Excelsior* to the tiniest armed warpshuttle. The system allows players to pick and choose engines, shields, weapons, computer, and superstructure strength to create warships of any class or type desired. It also allows gamers to create evenly-balanced sides for multi-ship and multi-player games.

CONTENTS OF THIS BOOK

The first sections are those that pertain to all races and to ship construction in general, including descriptions of the to all races and to ship construction in general, including descriptions of the Combat Efficiency System. Following this are the data tables for weapons, shields, engines, and so on, organized so that all of the information for each race is presented in the same place. The tables are in the same sequence as the blanks on the *Ship Construction Form*, which guides the gamer through the ship construction process.

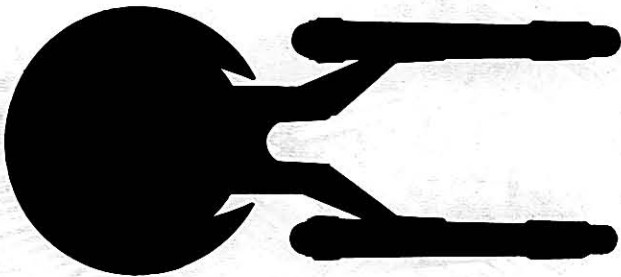

CONSTRUCTION TABLE TERMS

The following list defines and describes the terms used in the construction of vessels for starship combat. Some of these terms are to be found heading columns in the various Ship Construction Tables, and others pertain to the Ship Data Sheets in the various recognition manuals. Where a term is associated with particular units of measure, these are given.

CLASS

This number is an indication of the mass of a ship, its tonnage. The higher the class, the greater the ship's tonnage. The relationship between class and tonnage is not constant. For very low class numbers, the tonnage range is relatively small, and for very high class numbers, the tonnage range is relatively large; only in the middle of the class numbers are the tonnage ranges constant, as shown in the table. Most engines and shields are effective on certain classes of ships, as shown by their engine efficiency ratings and Shield Efficiency Ratings. Some weapons are restricted to certain classes of ships, because of the amount of computer support and superstructure required.

SHIP CLASSES

Class	Mass (mt)
I	0 - 5
II	5 - 15
III	15 - 25
IV	25 - 40
V	40 - 60
VI	60 - 80
VII	80 - 100
VIII	100 - 120
IX	120 - 140
X	140 - 160
XI	160 - 180
XII	180 - 210
XIII	210 - 240
XIV	240 - 300
XV	300 - 350
XVI	350 - 400
XVII	400 - 450
XVIII	450 - 500
XIX	500 - 600
XX	600 - 700

COMBAT EFFICIENCY (CE)

This number rates a ship's performance in combat; the higher the number, the more effective the ship in a head-to-head conflict. It is a measure of how the ship uses the power produced by its engines, the strength of its superstructure and deflector shielding, and the overall potency of its weapons.

CONTROL COMPUTER REQUIREMENT

Each engine, weapon, and shield generator aboard a ship is controlled by the ship's control computer. The more complex the equipment, the more sophisticated the computer must be. The Computer Requirement of the equipment is one of the three factors limiting ship construction. Although the computers weigh a very small amount in comparison to most ships, there is a range of Ship Classes for which each computer type is suitable, either because equipment needed to run a ship of a certain size is too complex or because the computer would be vastly overpowered for the equipment available.

DAMAGE

This number represents the damage done by a successful hit with a beam or missile weapon. The greater this number, the greater the damage. The damage of a beam weapon equals the amount of power put into it and any damage modifiers; thus, this number is not given in the beam weapon charts. The damage of a missile weapon is constant, and so it appears in the missile weapon charts. The damage from a Romulan plasma weapon is a special case, because it depends on the range, and so it is given in a special chart.

DAMAGE MODIFIER

This number is the bonus damage some beam weapons do at various ranges. Damage modifiers emphasize the different ways beam weapons convert power to damage. For most beam weapons, the damage modifiers will be greater at short ranges.

DAMAGE PENETRATION COEFFICIENT (DPC)

This number is a measure of how well a shield will prevent damage from incoming fire. It is related to the maximum shield power and the shield point ratio. The more efficiently a shield generator converts power to shielding (that is, the lower the shield point ratio), the lower the DPC. Because use of the shields reduces the power available for either movement or weapons, the greater the power needed for the generator to perform at maximum effectiveness, the higher the DPC.

DEFENSE FACTOR (D)

This number is a measure of the ship's Superstructure Strength, of the ship's shield strength, and of the efficiency with which the ship converts power to movement and to deflector shielding. The higher this number, the more effective the ship is in defense.

DISPLACEMENT

This number tells how much any piece of equipment or ship weighs. When dealing with ships, there is a direct relationship between a ship's mass and its class (see *CLASS*). When dealing with equipment, the displacement is one of the factors that help control ship design. Because of mass limits, it is impossible to put an enormous warp engine and all the phasers in the world on a warpshuttle. The mass of all pieces of equipment and superstructure must be less than the maximum mass allowed for a particular Ship Class.

FIRING ARC

The firing arc is the various directions, given relative to the ship's nose and tail, the ship's weaponry can fire. There are four arcs, somewhat overlapping: forward (*fwd*), aft, port, and starboard (*stbd*).

FIRING CHART

This is the column in the table that is to be used in determining the To-Hit Number for any weapon. This is given as a letter, with column A being used for the least effective weapon and column Y for the most effective.

IMPULSE ENGINE MOVEMENT EFFICIENCY RATING (IER)

This number rates an impulse engine's ability to produce power usable for combat maneuver. The greater this number, the more efficient the engine. The more effectively the engine produces its power (indicated by a lower Movement Point Ratio), the higher the IER will be. The more power an engine produces, the higher the IER will be. The IER is added to the Warp Engine Movement Efficiency Ratings (WER) and the Damage Penetration Coefficient (DPC) to help determine the ship's Power Efficiency.

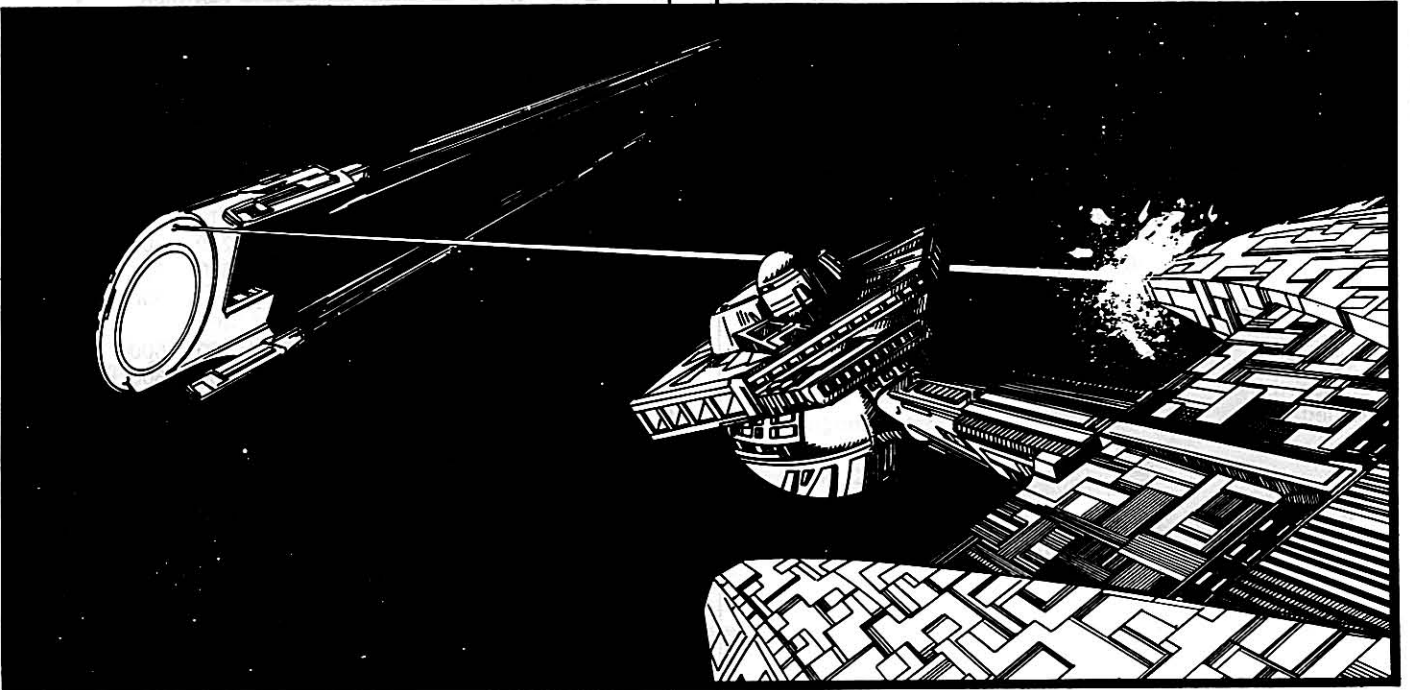

MAXIMUM BEAM POWER

This is the maximum power that may be put into the beam weapon, and, thus, the unmodified damage the weapon will do. The higher this number, the more devastating the weapon, and, thus, the higher the Weapon Damage Factor.

MAXIMUM WEAPON RANGE

This number tells the maximum distance that a weapon may fire. The more powerful the weapon system, the greater the range and the greater the Weapon Damage Factor. At some ranges, a beam weapon may give damage greater than the power used to arm it. These ranges are indicated in parenthesis for each damage modifier. The maximum weapon range is given in hexes, with each hex equal to 10,000 km.

MAXIMUM SHIELD POWER

This number is the greatest number of shielding points that the ship's shield generators can produce. It is directly related to the amount of power put into the generators. The larger the ship, the less effective any particular shield generator will be in protecting it, because the protection will be spread over a greater surface area. Thus, in general, the higher the Ship Class, the less the Maximum Shield Power for any given generator.

MOVEMENT POINT RATIO (MPR)

This fraction represents the number of power units required to give one movement point. If the fraction is greater than 1, such as 4/1, the engine is using power relatively inefficiently; the greater the fraction, the less efficient the engine's use of power for movement. If the fraction is equal to or less than 1, such as 1/1 or 1/2, then the engine is converting power into movement very efficiently; normally, this is possible only with very light ships. All engines on a ship must have the same movement point ratio, or the stresses produced will tear the ship apart.

POWER EFFICIENCY

This number, part of the calculation of a ship's Combat Efficiency, is a measure of the ship's use of power for movement and shielding. The higher this number, the more efficient the ship in combat. It is determined from the ship's engine efficiencies, Damage Penetration Coefficient, and Shield Efficiency Rating.

POWER TO ARM

This number tells how many power units are required to arm a missile weapon, such as a photon torpedo; unlike the power used to arm beam weapons, this has no effect on the damage done by the missile. More efficient missile weapon systems require only 1 power unit to arm them, whereas the less efficient (including most Klingon designs) require a Power To Arm of 2.

POWER UNITS AVAILABLE

This number tells how much power an engine produces that may be used for combat, either in movement, in shielding, or in weaponry. This is only part of the total power produced by the engine, but Combat Efficiency is not concerned with the power used in the life support systems, the computer control systems, the turbolifts and transporters, and so on. The power units available for the ship is the sum of the power units available from each engine. As could be expected, most warp engines produce far more power than most impulse engines, even if they are only idling at sub-light speeds.

SHIELD EFFICIENCY RATING (SER)

This number tells the relative efficiency of a shield generator; it is the reciprocal of the shield point ratio. The more efficiently the shield generator converts power into shielding, the higher the SER. This number is used directly in calculating Combat Efficiency.

SHIELD POINT RATIO (SPR)

This fraction tells how many shield points a generator may produce from 1 power unit. This number is determined by the generator type, and it does not vary from ship to ship. If the shield point ratio is equal to or greater than 1, such as 1/1 or 3/2, the generator uses power very inefficiently. If the shield point ratio is less than 1, such as 1/2 or 1/4, the generator uses power more efficiently. The smaller the ratio, the greater the generator's efficiency, and the greater the shielding that it will produce from 1 power unit.

STRESS COLUMN

These letters indicate the likelihood of stress to the superstructure and warp engines from emergency heading changes. The first letter, to the left of the slash (/), indicates the column on the Heading Change Stress Chart for the superstructure. The second letter, to the right of the slash, indicates the column for the warp engines. The column used depends on the engine and the Ship Class. In general, Column A indicates that damage is unlikely except at very high warp speeds, and Column R indicates that damage is likely at speeds as low as Warp 2.

SUPERSTRUCTURE REQUIREMENT

The engine and power systems, weapon systems, computer control systems, and shield generator systems require internal bracing to be effective. The amount of this bracing is the Superstructure Requirement of the system. In general, the larger, more complex the system, the larger the Superstructure Requirement. The total of the Superstructure Requirements must be less than the Superstructure Strength (SS) of the ship. Because each point of Superstructure Strength displaces 1500 mt, the Superstructure Requirement is one of the three factors controlling ship design.

SUPERSTRUCTURE STRENGTH (SS)

This number tells how much damage a ship's superstructure can withstand. Damage to the superstructure is subtracted from this number, and so the greater the Superstructure Strength, the more damage a ship can withstand, either from weapons fire or from stress. Engines, shield generators, control computers, and the like may require a minimum Superstructure Strength, which must be taken into account when the ship is constructed. The SS is added to the Power Efficiency when calculating a ship's Combat Efficiency. Obviously, the stronger the superstructure, the more efficient the ship in combat, because the more damage it will withstand. One point of Superstructure Strength is equivalent to internal bracing that displaces 1500 metric tons.

WARP ENGINE MOVEMENT EFFICIENCY RATING (WER)

This number rates an impulse engine's ability to produce power usable for combat maneuver. The greater this number, the more efficient the engine. The more effectively the engine produces its power (indicated by a lower Movement Point Ratio), the higher the WER will be. The more power an engine produces, the higher the WER will be. The WER is added to the Impulse Engine Movement Efficiency Rating (IER) and the Damage Penetration Coefficient (DPC) to help determine the Power Efficiency of a ship's engines.

WEAPON DAMAGE FACTOR (WDF)

This number is a measure of the relative destructive power of a weapon. It takes into account the weapon's maximum range, its ability to hit throughout this range, and the maximum damage it can do. The greater the range of a weapon, the greater the WDF; the greater the chance to hit at any range, the greater the WDF; and the greater the maximum damage, the greater the WDF. For missile weapons, the smaller the Power To Arm, the greater the WDF. The WDF is the most important factor in determining Combat Efficiency.

Constructing

NARROW THE FIELD

Because the choices available in ship construction are so many, designing a ship for combat will be a trial-and-error process, which will become easier with practice. At first, until you become familiar with the tables and the way the engines, shields, superstructure, computers, and weapons work together, it will be merely a matter of making variations on designs already published. These variations should be tested in combat to see what the effects are of altering the published stats, and only experience with the ship construction process will make the effects of any one design decision easier to predict beforehand.

Because the choices *are* so many, it is necessary to narrow the field somewhat, if only to keep your sanity. This requires some decision about the general characteristics of the ship that will be played. Will it be fast and very maneuverable, or will it be large and heavily-gunned? This initial choice will give a general *range* of ship classes to choose from. The glossary of *Ship Types* may be of value in this step.

Once this range has been decided upon (its exact limits need not be determined at this time), the tables must be inspected. This will give a basic familiarity with the equipment that may be used on the ship for each of the classes in the range. One or two classes likely will be obviously preferable, which will narrow the choice even more.

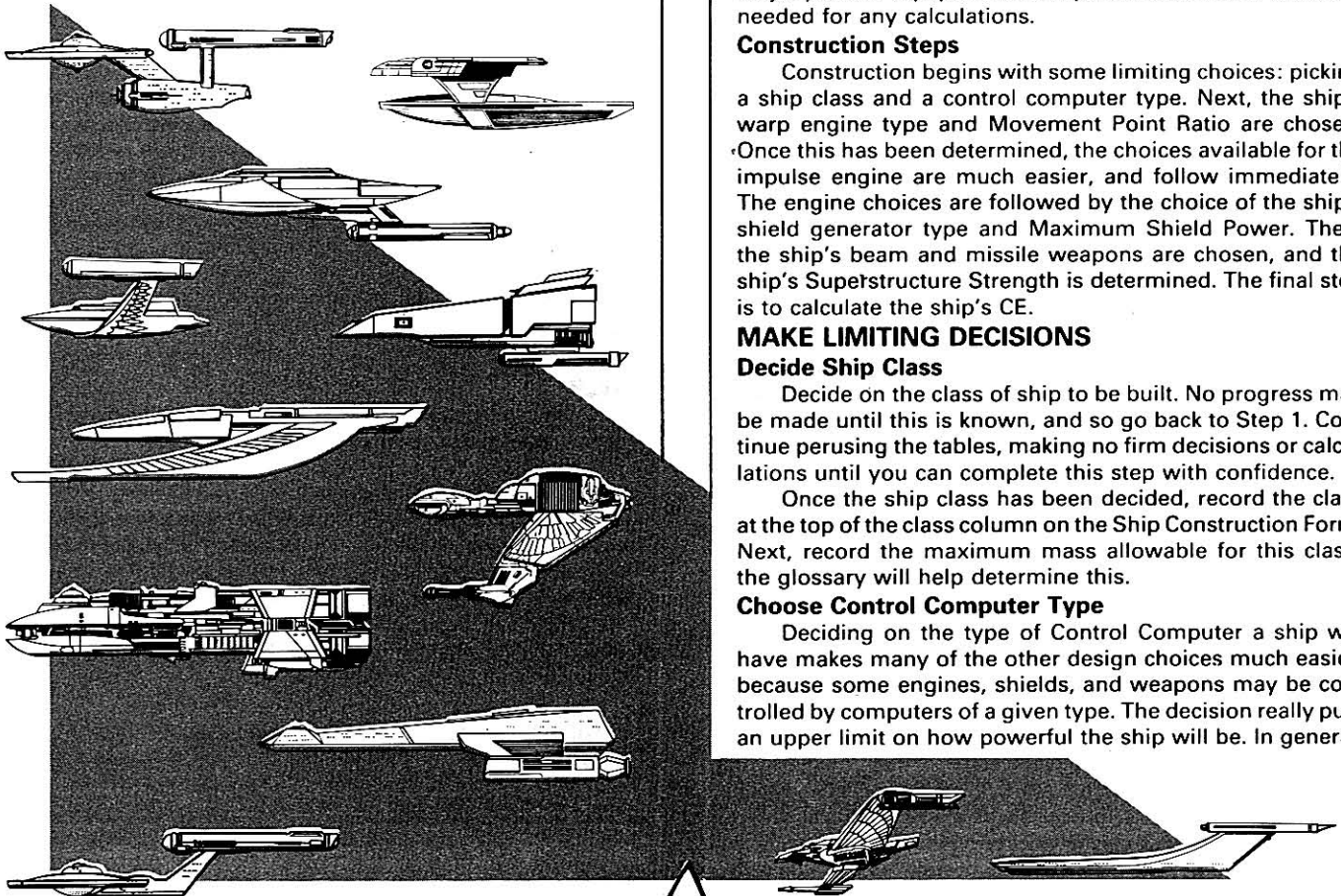

SELECT EQUIPMENT

The Ship Construction Form

In selecting the engines, shield generators, and weapons that the ship will carry, two things must be kept in mind. The first is that all the equipment be suitable for the ship class chosen, and the second is that the equipment be suitable for the control computer type chosen. In addition to these two considerations, the designer must keep a record of the Superstructure Requirements for each piece of equipment added to the ship, and the total mass of that equipment.

The Ship Construction Form has been designed to help do this. There are five columns on the form: one each for equipment, class, Superstructure Strength, and Combat Efficiency. The three left-hand columns are for the stats on all the equipment added to the ship, the mass of this equipment, and the value of the SS necessary to have the equipment on the ship at all; once the design is finished, these columns may be used to fill in the most important data on the Ship Data Sheet and the Master Control Panel. The large center section is used for all of the necessary calculations; the results of these calculations usually are put into one of the other columns. The column on the right is used to record the special equipment efficiency stats used in determining the ship's Combat Efficiency.

The form is separated into several parts, one for each major piece of equipment. Each part contains all of the steps needed for any calculations.

Construction Steps

Construction begins with some limiting choices: picking a ship class and a control computer type. Next, the ship's warp engine type and Movement Point Ratio are chosen. Once this has been determined, the choices available for the impulse engine are much easier, and follow immediately. The engine choices are followed by the choice of the ship's shield generator type and Maximum Shield Power. Then, the ship's beam and missile weapons are chosen, and the ship's Superstructure Strength is determined. The final step is to calculate the ship's CE.

MAKE LIMITING DECISIONS

Decide Ship Class

Decide on the class of ship to be built. No progress may be made until this is known, and so go back to Step 1. Continue perusing the tables, making no firm decisions or calculations until you can complete this step with confidence.

Once the ship class has been decided, record the class at the top of the class column on the Ship Construction Form. Next, record the maximum mass allowable for this class; the glossary will help determine this.

Choose Control Computer Type

Deciding on the type of Control Computer a ship will have makes many of the other design choices much easier, because some engines, shields, and weapons may be controlled by computers of a given type. The decision really puts an upper limit on how powerful the ship will be. In general,

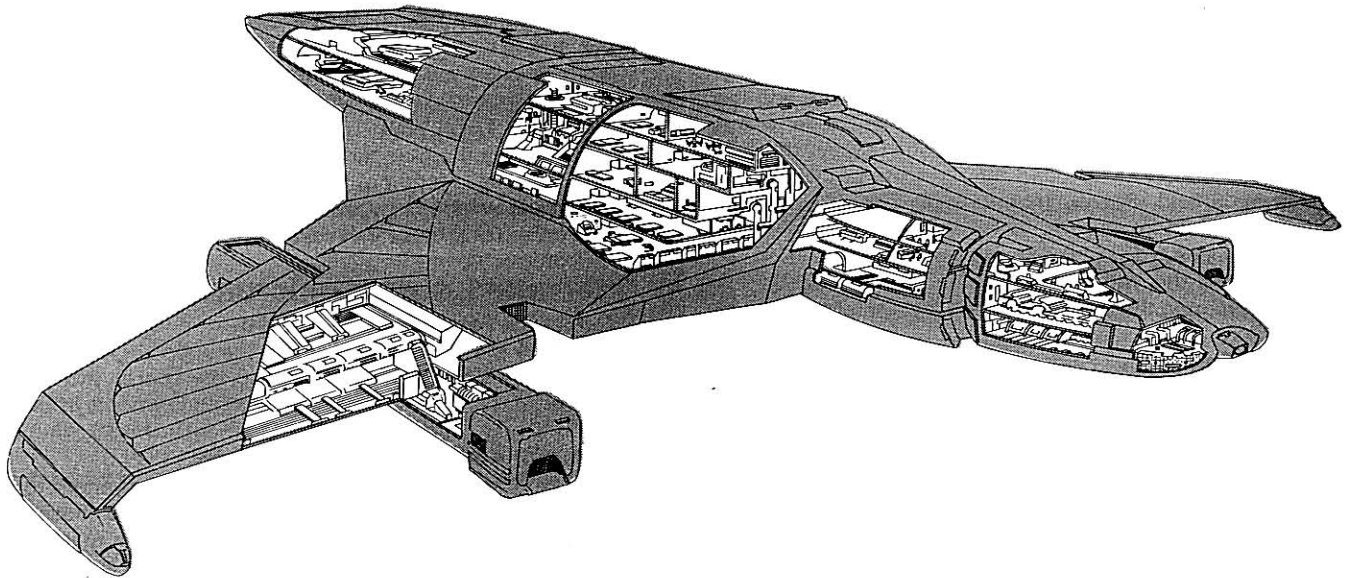

the more powerful the ship in terms of Total Power Units Available from the engines, the maneuverability, the strength of shielding, and the range and destructive ability of the weapons, the more complex the computer necessary to do the job.

Making this decision requires you to compare several different tables. Not all ship classes are suitable for every computer type, and so it will be necessary to use the *Computer Types* Table to determine which computers may be used with which ship classes. Then, the *Control Computer Suitability* Table will show which engines, shield generators, and weapons may be controlled by any of the types that are suitable. Once again, it will be a trial-and-error process that may be repeated at a later point if you find that your initial choice is not satisfactory.

Once a control computer type has been chosen, record this in the equipment column of the Ship Construction Form. Record mass in the class column, SS Requirement in the SS column, and Maximum WDF Allowed in the CE column.

CHOOSE WARP ENGINE TYPE

Select Engine Type And MPR

The choice of warp engine type and the number of engines the ship will carry is made by using two tables, the *Movement Point Ratio* Table and the *Control Computer Suitability* Table. First, the *Movement Point Ratio* Table will tell which warp engines may be used on ships of the chosen class, either singly or in tandem. The computer table will tell which of these engines may be controlled by the chosen computer type.

To use the *Movement Point Ratio* Table, find the ship class in the column at the right. In the boxes along this row are listed the various warp engines that may be used at various Movement Point Ratios. To find the choices that are available, use the *Control Computer Suitability* Table.

Use the *Warp Engine Types* Table to select a warp engine type and Movement Point Ratio. To use this table, find the engine type in large bold print. Then, find the part of the table that gives the details on using the number of warp engines chosen, single for one engine and tandem for two. Next, find the row or rows that contain the chosen ship class in the Ship Classes Powered column. The Movement Point Ratio column will tell the various ratios available.

From this data on the choices available, select a warp engine type and Movement Point Ratio.

Record Engine Stats

Record the warp engine type chosen and the Movement Point Ratio in the equipment column of the Ship Construction Form. Record the number of these engines that will be used.

The remaining engine stats are read from the *Warp Engine Types* Table. In the equipment column, record the values given for the Power Units Available, the Stress Columns, the Maximum Safe Cruising Speed, and the Emergency Speed. Record the mass in the class column, the SS Requirement in the SS column, and the WER in the CE column.

CHOOSE IMPULSE ENGINE TYPE

Select Engine Type

In a similar way, the *Movement Point Ratio* Table and the *Control Computer Suitability* Table may be used to pick the impulse engine type, though this is much easier because the Movement Point Ratio is already known. Use the *Movement Point Ratio* Table by cross-indexing the ship class with the Movement Point Ratio chosen. This gives a list of impulse engine types that may be used. Use the computer table to find the types that may be controlled by the computer type chosen; any engine is suitable if it may be controlled by a computer as powerful or less powerful than the one chosen to control the warp engine(s).

Then, use the *Impulse Engine Type* Table to choose a specific impulse engine type by comparing the stats of each engine available. Find the engine type in bold print and use the Movement Point Ratio column to find the appropriate row. Match the Ship Classes Powered with the ship class chosen, and the Control Computer with the type chosen, just to be sure that the engine can be used.

Record Engine Stats

Record the engine type and Power Units Available in the equipment column, the mass in the class column, the SS Requirement in the SS column, and the IER in the CE column.

Calculate Total Power Available

Copy the power units available for all engines into the spaces provided in the calculations column. Total these values, as indicated, and record the Total Power Units Available in the equipment column.

CHOOSE SHIELD GENERATOR TYPE

Select Generator

The *Control Computer Suitability* Table and the *Shield Point Ratio* Table are used in selecting the generator type.

The computer table will give the shield generator types that may be used for a given computer type. Any generator may be chosen that can be controlled by a computer less powerful than the type chosen to run the warp and impulse engines.

The *Shield Point Ratio* Table compares the various shields on ships of a given class. To use this table, find the ship class in the left-hand column and the shield generator type, the Shield Point Ratio, and the SER across the top. Cross-index the ship class and the shield type to read the Maximum Shield Power (non-italics). The greater the Maximum Shield Power, the more protection that a shield generator will afford, and the smaller the Shield Point Ratio, the less power this will take.

By comparing the shield stats, choose a shield generator type.

Record Shield Stats

Record the shield generator type, the Shield Point Ratio, and the Maximum Shield Power in the equipment column. Record the DPC, which is the number in italics just below the Maximum Shield Power, in the CE column.

Use the *Shield Generator Types* Table to find the rest of the shield stats. Find the generator type in the left-hand column, and read the stats in that same row. Record the mass in the class column, the SS Requirement in the SS column, and the SER in the CE column.

Calculate Power Efficiency

Copy the total WER, the IER, the DPC, and the SER into the appropriate spaces in the calculations column. Total the WER, IER, and DPC, as indicated, and multiply the sum by the SER. Record the Power Efficiency (PE) in the CE column.

CHOOSE WEAPON TYPES

Select Weapons

Use the *Beam Weapon Types* Table in selecting the ship's beam weaponry. The table will tell the total WDF that may be controlled by the computer type chosen. Any weapon type and number may be chosen as long as the computer supports the total WDF. Generally there will be no more than two different beam weapons on a ship, but sometimes there will be three and rarely four. A ship with missile weapons will only have one missile weapon type.

The *Beam Weapon Types* Table gives the stats for each beam weapon. Particularly important is the Maximum Beam Power, the Firing Chart, and the mass. To use this table, find the beam weapon type in the left-hand column, and read the stats in that row. Comparing one weapon with another, choose the ship's beam weapon type(s) and numbers. For each weapon or weapon bank, select the Firing Arc.

The *Missile Weapon Types* Table gives the stats for each missile weapon. The important stats for choosing missile weapons are the Firing Chart, the mass, the Power To Arm, and the Damage. Comparing one weapon with another, choose the ship's missile weapon type (only one type per ship) and number. For each weapon, select either the forward or aft firing arc.

Record Weapon Stats

Record each beam weapon type, number, Damage Modifiers, Firing Chart, and Firing Arcs in the equipment column. Record the mass, SS Requirement, WDF, and number of each type in the calculations column.

Record the missile weapon type, number, Power To Arm, Damage, Firing Chart, and Firing Arcs in the equipment column. Record the mass, SS Requirement, WDF, and number in the calculations column.

Calculate Total Weapon Mass

Multiply the mass of each beam weapon by the number of that weapon type, and multiply the mass of each missile weapon by the number of missile weapons, as indicated in the calculations column. Total these values, and record the Total Weapon Mass in the class column.

Calculate Weapon Superstructure Strength

Multiply the number of each beam weapon type by the SS Requirement for each weapon of that type, and multiply the number of missile weapons by the SS Requirement for each weapon. Total these numbers, and record the Weapon SS Requirement in the SS column.

Calculate Total WDF

Multiply the number of each beam weapon type by the WDF for one weapon of that type, and multiply the number of missile weapons by the WDF for one missile weapon of that type. Total these values, and copy the Total WDF in the CE column.

DETERMINE SUPERSTRUCTURE STRENGTH

Calculate Total SS Requirement

Copy the SS Requirement for the warp engines, impulse engine, shields, and weapons into the spaces provided in the calculations column. Total these requirements (rounding up), and record the Total SS Requirement in the SS column.

Determine Superstructure Strength

Choose some additional superstructure strength to add to the SS Requirement. The more additional SS chosen, the longer the ship will last in combat, the more mass it will have, and the higher Combat Efficiency Value it will end up with. Record the additional SS in the SS column, and add this to the Total SS Requirement. Record the Superstructure Strength in the SS column.

Calculate SS Mass

Multiply the Superstructure Strength by 1500 to find the mass of the superstructure. Record this SS Mass in the class column.

CHECK TOTAL Mass

Calculate Total Mass

Copy the total mass for the warp engines, the impulse engines, the shield generators, and the weapons into the spaces provided in the calculations column. Total the mass, and record the total ship's mass in the class column.

Compare Mass

Compare this sum to the maximum mass allowed for the ship class chosen. If the sum is less than the maximum mass allowed for the ship class chosen, and greater than the minimum mass allowed for that class, the design process is complete.

Adjust Mass

If the the sum is less than the minimum mass allowed, increase the mass until it is greater than the minimum. If the sum is greater than the maximum mass allowed, the mass must be decreased.

The easiest place to decrease mass is by altering the superstructure strength. Remove as much of the additional superstructure strength as necessary to bring the total mass below the maximum mass.

If this does not work, or if it is undesirable to reduce the superstructure strength, adjust the weapons. This may be done either by decreasing their number (easy) or by decreasing the weapon size (harder). Recalculate the Total Weapon Mass, and adjust other stats accordingly.

If it still does not work, repeat the design process, but use a lighter warp engine.

CALCULATE COMBAT EFFICIENCY

Calculate Defense Factor

Copy the Power Efficiency and Superstructure Strength values into the calculations column. Multiply the SS by 1.43 and add the Power Efficiency to get the Defense Factor (D). Record this in the CE column.

Calculate CE

Copy the Total WDF and the Defense Factor into the calculations column. Multiply the two and record the CE in the CE column. This completes the design process.

SHIP CONSTRUCTION FORM

CE

Equipment

Class

SS

Calculations

Ship Class

Maximum Ship Mass _____ mt

Choose Ship Class

Choose Control Computer Type

Maximum WDF _____

Computer Type

Mass _____ mt

SS Requirement

Choose Warp Engine Type

Warp Engine Type

Number _____

Movement Point Ratio _____

Power Units

Mass _____ mt

SS Requirement

Available _____

Stress Columns

Max. Safe Cruising

Emergency Speed

Speed _____

WER _____

Impulse Engine Type

Mass _____ mt

SS Requirement

Power Units

Available _____

Total Power Units

Available _____

Choose Impulse Engine Type

Calculate Total Power Units Available

$$\text{Total Power Units Available} = \frac{\text{Warp Engine 1}}{\text{WER}} + \frac{\text{Warp Engine 2}}{\text{WER}} + \frac{\text{Impulse Engine}}{\text{IER}} = \underline{\hspace{2cm}}$$

IER _____

Shield Generator

Type _____

Maximum Shield

Power _____

Mass _____ mt

Shield Point

Ratio _____

SS Requirement

Choose Shield Generator Types

Calculate Power Efficiency

$$\text{Power Efficiency} = \left(\frac{\text{WER}}{\text{WER}} + \frac{\text{IER}}{\text{IER}} + \frac{\text{DPC}}{\text{DPC}} \right) \times \frac{\text{SER}}{\text{SER}} = \underline{\hspace{2cm}}$$

DPC _____

SER _____

Power Efficiency _____

Beam #1 Type

Number _____

Damage Modifiers

+3 (____ - ____)

+2 (____ - ____)

+1 (____ - ____)

Mass _____ mt

Firing Chart

Firing Arcs

SS Requirement

Firing Arcs

Choose Weapon Types

Calculate Total Weapon Mass

$$\#1 \text{ Beam Mass} = \frac{\text{Mass}}{\text{Mass}} \times \frac{\text{Number}}{\text{Number}} = \underline{\hspace{2cm}}$$

$$\#2 \text{ Beam Mass} = \frac{\text{Mass}}{\text{Mass}} \times \frac{\text{Number}}{\text{Number}} = \underline{\hspace{2cm}}$$

$$\text{Missile Mass} = \frac{\text{Mass}}{\text{Mass}} \times \frac{\text{Number}}{\text{Number}} = \underline{\hspace{2cm}}$$

WDF, #1 _____

Beam #2 Type

Number _____

Damage Modifiers

+3 (____ - ____)

+2 (____ - ____)

+1 (____ - ____)

Mass _____ mt

Firing Chart

Firing Arcs

SS Requirement

Firing Arcs

Calculate Weapon Superstructure

$$\#1 \text{ Beam Superstructure} = \frac{\text{SS}}{\text{SS}} \times \frac{\text{Number}}{\text{Number}} = \underline{\hspace{2cm}}$$

$$\#2 \text{ Beam Superstructure} = \frac{\text{SS}}{\text{SS}} \times \frac{\text{Number}}{\text{Number}} = \underline{\hspace{2cm}}$$

$$\text{Missile Superstructure} = \frac{\text{SS}}{\text{SS}} \times \frac{\text{Number}}{\text{Number}} = \underline{\hspace{2cm}}$$

WDF, #2 _____

Missile Type

Number _____

Power To Arm

Damage _____

Mass _____ mt

Firing Chart

Firing Arcs

SS Requirement

Firing Arcs

Calculate Total WDF

$$\#1 \text{ Beam WDF} = \frac{\text{WDF}}{\text{WDF}} \times \frac{\text{Number}}{\text{Number}} = \underline{\hspace{2cm}}$$

$$\#2 \text{ Beam WDF} = \frac{\text{WDF}}{\text{WDF}} \times \frac{\text{Number}}{\text{Number}} = \underline{\hspace{2cm}}$$

$$\text{Missile WDF} = \frac{\text{WDF}}{\text{WDF}} \times \frac{\text{Number}}{\text{Number}} = \underline{\hspace{2cm}}$$

WDF, Missile _____

Total WDF _____

Calculate Total SS Requirement

$$\text{Warp} + \text{Impulse} + \text{Shield} + \text{Computer} + \#1 \text{ Beam} + \#2 \text{ Beam} + \text{Missile} = \underline{\hspace{2cm}}$$

Component Mass _____

Total SS Required _____

SS Mass _____

Additional Superstructure _____

Total Ship's Mass _____

Total Ship's SS _____

Calculate SS Mass

$$\text{SS Mass} = \frac{\text{SS}}{\text{SS}} \times 1500 = \underline{\hspace{2cm}}$$

Calculate Defense Factor

$$\text{Defense Factor} = \frac{\text{Power Efficiency}}{\text{Power Efficiency}} + \left[\frac{\text{SS}}{\text{SS}} \times 1.43 \right] = \underline{\hspace{2cm}}$$

WDF _____

D _____

CE _____

$$\text{CE} = \frac{\text{D}}{\text{D}} \times \frac{\text{WDF}}{\text{WDF}} / 100 = \underline{\hspace{2cm}}$$

Combat Efficiency

The efficiency of a starship in combat depends on two broad factors - how long it can withstand enemy fire and how much damage it can do before it is destroyed. Combat Efficiency values may be calculated from the data provided in the ship construction tables. They are a function of the way the ship is constructed, and so they are intimately related to the way the ship uses the power produced by its engines, the strength of its superstructure and deflector shielding, and the overall potency of its weapons.

COMBAT EFFICIENCY FORMULA

The Combat Efficiency (CE) of a ship may be expressed by the following formula:

$$\text{Combat Efficiency (CE)} = \text{Defense Factor (D)} \times \text{Weapon Damage Factor (WDF)} / 100$$

In this formula, the Defense Factor takes into account the efficiency with which the ship's warp and impulse engines convert their power to movement and shielding, the strength of the ship's deflector shields, and the Superstructure Strength. This factor may be expressed as follows:

$$\text{Defense Factor (D)} = \text{Power Efficiency} + \text{Superstructure Strength}$$

or

$$D = (\text{WER} + \text{IER} + \text{DPC}) \times \text{SER} + (1.43 \times \text{SS})$$

This formula includes the following construction values:

- WER** = Warp Engine Movement Efficiency Rating
- IER** = Impulse Engine Movement Efficiency Rating
- DPC** = Damage Penetration Coefficient
- SER** = Shield Efficiency Rating
- SS** = Superstructure Strength



USING THE FORMULA

To determine the Combat Efficiency of a ship when the construction values have already been determined, simply substitute the values for each in the appropriate place in the formula. A hand calculator makes the job much easier.

FINDING THE DEFENSE FACTOR

First, find the Power Efficiency. Second, calculate the Superstructure Strength. Third, add these values to find the Defense Factor.

Power Efficiency

First, determine the Warp Engine Movement Efficiency Rating (WER) and Impulse Engine Movement Efficiency Rating (IER) for the ship's engines, and the Damage Penetration Coefficient (DPC) and Shield Efficiency Rating (SER) for the ship's shields. These values may be found in the Ship Construction Tables for each engine configuration (type, number, and movement point ratio) and shield configuration (type, maximum shield power, and shield point ratio).

Next, add the WER, the IER, and the DPC together, retaining any decimals.

Last, multiply the sum by the SER, and round to one decimal place.

For example, the Larson Class VII Destroyer has 1 FWC-2 warp engine that delivers 20 power units with a Movement Point Ratio of 2/1, giving a WER of 14.5. Its FIB impulse engine delivers 2 power units at the same Movement Point Ratio, for an IER of 1.5. Its FSC shield generators give a maximum shield power of 8 at a shield point ratio of 1/1; this shield configuration has a SER of 1 and a DPC of 4.5. This means that the Power Efficiency of the ship is 20.5 (14.5 + 1.5 + 4.5 = 20.5; 20.5 x 1 = 20.5).

Superstructure Strength

To find the Superstructure Strength (SS), first determine the total superstructure points. Next, multiply this by 1.43, retaining one decimal place.

In our example, the Larson has 10 superstructure points. Multiplying by 1.43 gives 14.3, the Superstructure Strength.

Defense Factor

To find the Defense Factor (D), add the Power Efficiency and the Superstructure Strength. Retain 1 decimal place.

For the Larson, the Power Efficiency is 20.5. Adding the Superstructure Strength of 14.3 gives the ship a D of 34.8.

FINDING THE COMBAT EFFICIENCY

To find the Weapon Damage Factor of a ship, total the WDF values for each of the ship's weapons. Multiply the WDF by the Defense Factor, divide by 100, then round to 1 decimal place to get the Combat Efficiency.

The Larson has 6 FH-4 phasers, with a WDF of 2.6 each. It also has 2 FP-2 photon torpedoes with a WDF of 2.0 each. Thus, the ship's WDF is 17.8 (13.8 + 4 = 17.8).

Multiplying the Defense Factor of 34.8 by the WDF of 17.8 gives 619.4. Dividing this by 100 and rounding to 1 decimal place gives 6.2, the Combat Efficiency of a Larson.

USING COMBAT EFFICIENCIES

In starship combat, the Combat Efficiency of two ships may be compared. Given average luck and identical skill on the part of the two Captains, the ship with the higher CE theoretically will be victorious.

The problem with reality is that luck is *not* average, and two Captains rarely have the same skill. Thus, the Combat Efficiency should be an indicator of which ships will be close matches in a head-to-head confrontation. For example, the CE of a *Constitution* Class ship is 38.5, and that for a *D-10* is 36.4, indicating that these ships will be good matches for one another in a duel.

The use of D, WDF, and CE allows long-range planning of campaigns, in which the choice of ships for the campaign is not made arbitrarily. It allows ship construction to be a useful factor in detailed long-range goals.

POWER EFFICIENCY

The Power Efficiency factor takes into account the way the ship allocates power to movement and power to shields.

The ship's actual movement in combat is not necessary for a calculation of its *theoretical* Combat Efficiency, but this will certainly have a bearing on the outcome of any real combat! With only so much power available, if the ship wishes to move, it must spend power to do this at the expense of shielding and weapon strength, and so it is the efficiency of movement that is calculated here.

In a similar way, the power converted to shields can vary from game turn to game turn, and so the actual shielding in any real combat will vary tremendously. Nevertheless, the *theoretical* Combat Efficiency can be calculated, for the power given to shields takes away from that which can be given to movement or weapons.

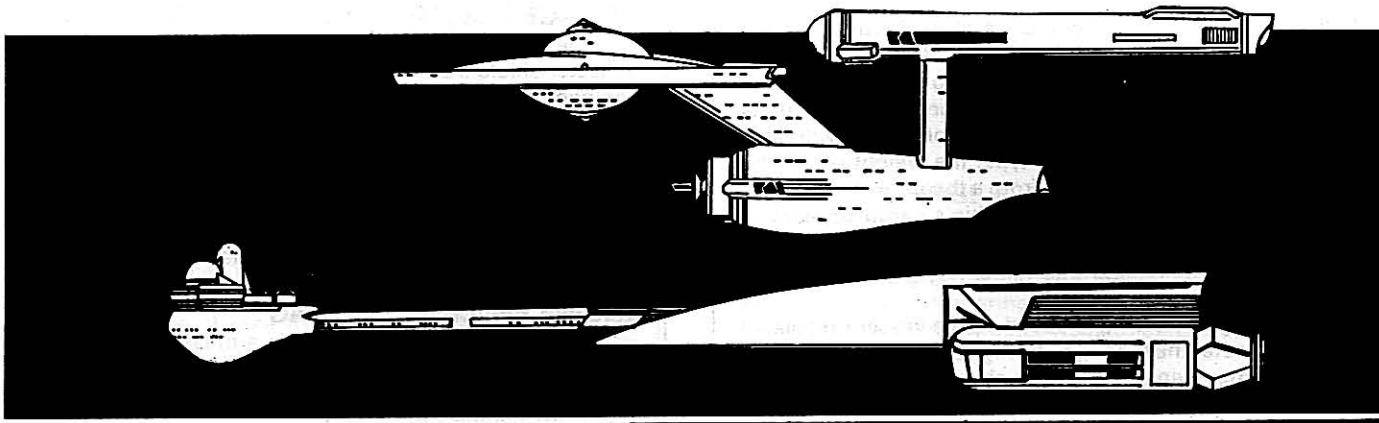

ORIGIN OF THE CE FORMULA

The Combat Efficiency Formula owes its origin to the work done by Don Turnbull for fantasy monsters, in which he pointed out that the aggressiveness of a monster depends on how many combat rounds it can survive an attack from a theoretical standard swordsman and on how much damage the monster could deliver in that time to a theoretical standard target. Assumptions were made that the monster stood still while the standard swordsman, hacked away, and that the target stood still while the monster did his damage in return.

This original thinking needed to be modified for the **STAR TREK Starship Combat Role Playing Game** for several reasons. The most obvious of these is that the ships do not combat hand-to-hand, and so provision had to be made for ranged attacks. The second is that ships do not stay positioned in one spot relative to one another during the game, and so provision had to be made that included the possibility of movement. The most crucial change, however, and the one that makes the Combat Efficiency Formula the most different, is the provisions made in the formula for the game mechanics of splitting total power into movement, weapons, and shields.

In deriving the values given in the tables, a standard starship (not one that would really be built) was designed to be both the attacker and the defender. This standard starship was designed to be the lowest-power ship that could be expected to participate regularly in starship combat. In determining DPC values and SS values, this ship's weaponry was used, and its power figures into the final DPC and SS for each engine and shield configuration. In determining WDF values, this ship was used as a target, with the value of its shields figured into the final WDF for any weapon.

The power given to weapons is assumed to be maximum, for maximum damage, because a ship has NO Combat Efficiency without weapons. In some heavily-armed ships, the power needed to arm all weapons to their maximum is greater than the power available, but this is ignored. Because this is maximum, it does not matter how much power is actually given to the weapons during any game turn, and so this power use is reflected in the Weapon Damage Factor.

SUPERSTRUCTURE STRENGTH

It is the superstructure of the ship that averages the most damage in combat. (About half of all possible hits give direct superstructure damage.) Thus, it is the superstructure that usually is demolished first by enemy fire, and so its strength is the most important and the controlling factor in determining how long a starship can exist once its shields are down.

The SS value in the formula is the number of superstructure points the ship has, and the coefficient of 1.43 reflects the value of this superstructure with respect to the weapons of the standard ship.

WEAPON DAMAGE FACTOR

The WDF in the formula reflects the full potency of the ship's weaponry, regardless of the firing arcs for each weapon or whether all weapons can be fully-powered at any one time. This number not only includes the power allocated to the weapon and the damage done by the weapon, but the distance at which the weapon can strike for damage. Thus, any weapon that has a lower power-to-damage ratio, a higher set of damage modifiers, a greater damage potential, and a longer range will have a higher WDF. The WDF values in the tables reflect the damage any weapon does against the standard starship's shield and superstructure.

Ship Construction Glossary

The following lists of terms pertain to one or another facet of ship construction. One list defines and describes terms relating to the areas in a ship, from the airlock to the weapon mounting hardpoint. Another list gives the terms used in ship evaluation and design, including the definitions for the various terms used in rating the combat efficiency of ship. A third list gives the basic descriptions of the types of combat ships most commonly built, and a fourth describes the most common non-combat and commercial starships.

EVALUATION AND DESIGN TERMS

CARGO UNIT

A cargo unit is the volume of cargo that would occupy 6.75 cubic meters of space, or a volume of 1.5 meters wide, 1.5 meters long, and 3 meters tall. Cargo holds on military and civilian ships are measured in standard cargo units (SCU). Although the actual weight of one SCU will vary widely depending on the cargo type, the weight of a fully-loaded ship will not vary greatly from a theoretical maximum set by the rated cargo capacity. A ship's cargo capacity is determined by using the theoretical weight of 50 metric tons per SCU, which is about 3/4 the weight of water.

CLASS

The class of a starship is based on the vessel's displacement. The greater the tonnage, the higher the class, as shown in the accompanying table. The ship designer most frequently decides on the ship class before he makes the other decisions needed in constructing a ship.

SHIP CLASSES	
Class	Mass (mt)
I	0 - 5
II	5 - 15
III	15 - 25
IV	25 - 40
V	40 - 60
VI	60 - 80
VII	80 - 100
VIII	100 - 120
IX	120 - 140
X	140 - 160
XI	160 - 180
XII	180 - 210
XIII	210 - 240
XIV	240 - 300
XV	300 - 350
XVI	350 - 400
XVII	400 - 450
XVIII	450 - 500
XIX	500 - 600
XX	600 - 700

There is a relationship between the class of a vessel and the movement point ratio. For any engine, the greater the class the greater number of power units are required to propel the ship over a given distance.

COMBAT EFFICIENCY

A vessel's combat efficiency (CE) is a measure of how the vessel will perform in combat. The efficiency of the ship's warp and impulse engines, of its shields, of its superstructure, and of its weaponry all combine to make the combat efficiency.

When comparing the battle capability of two vessels, the combat efficiency ratings of each are compared. In a head-to-head confrontation with commanders of equal skill, the vessel with the higher combat efficiency likely will be the victor. In multi-ship confrontation simulations, the Defense factor (D) and the Weapon Damage Factor (WDF) of both sides are totaled to determine the evenness of the two sides.

DAMAGE PENETRATION COEFFICIENT

The damage penetration coefficient is a measure of a deflector shield's efficiency in combat. The greater the damage penetration coefficient, the more damage can penetrate the shield from any given weapon. The damage penetration coefficient is determined from its maximum power and the generator's shield point ratio. Thus, it is roughly related to a ship's class, for a shield's maximum power is related to the ship's size. The damage penetration coefficient (DPC) is used to determine a ship's defense factor and its combat efficiency.

ENGINE EFFICIENCY RATING

The engine efficiency rating is a measure of a warp or impulse engine's use of the power it has available. Thus, the more efficient the engine, the greater the efficiency rating. The warp engine efficiency rating (WER) and the impulse engine efficiency rating (IER) are used to help determine the ship's defense factor and combat efficiency.

There also is a relationship between an engine's efficiency rating and the ship's displacement. In general, the greater the class of ship, the less the engine efficiency rating for a given engine, because the engine has more mass to push around.

MASS

The mass of a ship, usually measured in metric tons, is its displacement. The greater the mass of a ship, the more its engines must work to move the vessel through space. The class of a ship is directly determined by its mass. See CLASS.

MAXIMUM SHIELD POWER

The maximum shield power of a shield generator, usually measured in millions of joules, is a measure of the damage that the shield can dissipate from a direct hit. (A joule is the amount of energy needed to move 1 mt. a distance of .1 m.) For any shield generator, the maximum power that may be generated depends on the surface area that must be shielded. The greater the surface area, the less the maximum shield power that may be generated. This means that, for ships of the same basic configuration, the maximum shield power is roughly related to the ship class.

MOVEMENT POINT RATIO

A vessel's movement point ratio is a measure of the efficiency with which the engine's power is converted to movement. It is equal to the number of engine power units (10 megawatts) needed to move the ship one standard distance (10,000 km). Thus, movement point ratios frequently are 6/1, 5/1, 4/1, 3/1, 2/1, 3/2, or even 1/1. Sometimes, for exceptionally efficient ships, less than one engine power unit will move a ship several standard distance units; in these cases, the movement point ratio will be 1/2, 1/3, or 1/4.

POWER UNITS AVAILABLE

The power available from an engine for use in combat is measured in power units, each equal to 10 megawatts. This power is converted to maneuver, to movement at sub-light speeds, to weaponry, and to shielding. The power units available from an engine is used to determine the engine's efficiency rating.

SHIELD POINT RATIO

The efficiency with which a shield generator converts its power into shielding determines the generator's shield point ratio. The shield point ratio is found by dividing one power unit (10 megawatts) by the number of shield points (10 million joules of energy) that are produced by the generator. The lower the ratio, the greater the shield generator's efficiency. Shield point ratios for most generators are 1/4, 1/3, 1/2, or 1/1. Sometimes more power is required to produce even 1 shield point; in these cases, the shield ratios are 3/1, 2/1, or 3/2. The shield point ratio is the inverse of the shield effectiveness rating (SER), which effects the combat efficiency of a vessel.

STANDARD DISTANCE

A standard distance equals 10,000 km. This is represented on standard mapsheets by 1 hex. If a ship marker moves 12 hexes on a mapsheet, it moves 12 x 10,000 km, or 120,000 km.

STRESS CHART

When a ship makes a heading change at elevated warp speeds, damage may result from the stress given to the engine mountings and other related superstructure, or to the engine itself. The chance for this to occur is given in the various columns of the Stress Chart. The columns on the Stress Chart, designated by letters, are listed with the other engine and power data on all ship data sheets.

SUPERSTRUCTURE STRENGTH

The superstructure strength of a vessel is a theoretical number describing the ship's structural integrity. It is the amount of structural reinforcement necessary to just equal the damage taken from 10 million joules of energy, or one damage point; this weighs 1500 metric tons. It also is the amount of structural reinforcement necessary to be the equivalent of one shield point. The superstructure strength (SS) is used in figuring a ship's defense factor and its combat efficiency.

WARP SPEED

The speeds faster than light-speed produced by warp engines are known as warp speeds. The various warp speeds are designated by warp factors; the speed is the cube of the warp factor multiplied by the speed of light. Thus, Warp 1 is $1 \times 1 \times 1 = 1$ times the speed of light. Warp 2 is $2 \times 2 \times 2 = 8$ times the speed of light, and so on.

Two warp speeds are listed with the engine and power data for each ship. The first of these, the ship's Maximum Safe Cruising Speed, tells the maximum warp speed that the ship may travel in normal use. The second, the ship's Emergency Speed, tells the maximum warp speed that the ship may travel.

WEAPON DAMAGE

The damage done by a beam or missile weapon is measured in damage points equal to 10 million joules of energy. This damage is absorbed by the deflector shield, and thus, for the purpose of computing damage done to a ship, the damage points are subtracted from the shield points powered by a given shield. As a shield absorbs damage, the protection afforded by the shield generator is eroded away, until the shield protection is gone; it is then that the ship takes damage.

In combat, the damage done by a weapon salvo is subtracted from the shielding; when the damage exceeds the shield protection, then the ship's superstructure, engines, weapons, shields, or crew take damage.

WEAPON DAMAGE FACTOR

The efficiency of a beam or missile weapon is determined by the average damage this weapon will do over its entire range against a given shield. One weapon may be compared with another by comparing their weapon efficiency factors. The weapon with the greater weapon efficiency factor is the more powerful.

The efficiency of two ship's weaponry may be compared by totalling the weapon efficiency factors of all of the weapons the ship bears. The ship with the greater total has the more powerful weaponry, though it may not be the more effective in combat if the ships have substantially different engine efficiencies or damage penetration coefficients.

WEAPON POWER REQUIREMENT

A weapon's power requirement is measured by how many power units (10 megawatts) are necessary to arm and discharge the weapon. For missile weapons, the power to arm the weapon usually is 1 or 2 power units. For beam weapons, the power put into the weapon is variable, and the weapon power range may be as small as 0 - 1 or as great as 0 - 10.

For missile weapons, the damage produced bears little relationship to the power requirement. For beam weapons, the damage energy produced (measured in damage points of 10 million joules each) is equal to the power units put into the weapon.

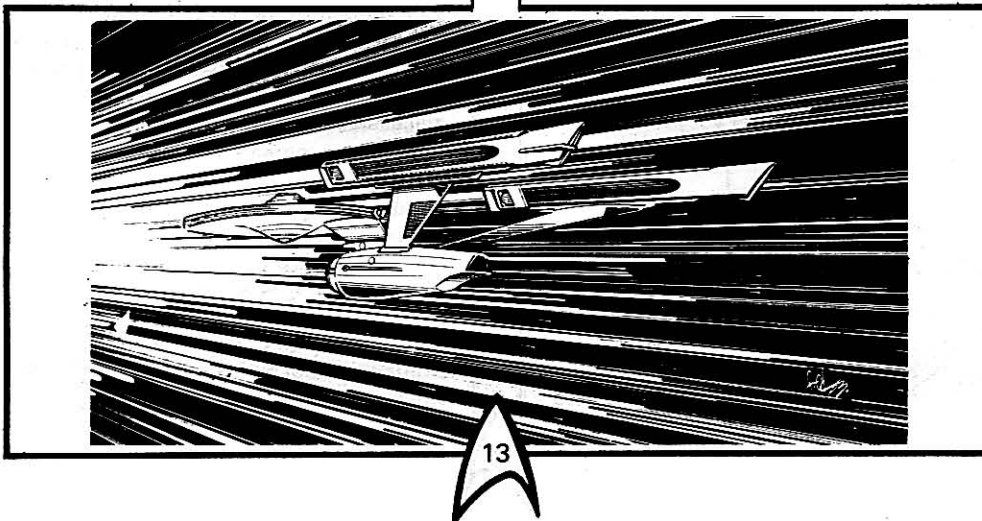

SHIPBOARD AREAS

The following paragraphs describe the internal characteristics of the major areas aboard a starship. They tell the use and give other information about each area, and the accompanying diagrams show typical equipment and layouts for each area.

AIRLOCK

An airlock is designed for one thing: to allow the passage of people or things from an area at one air pressure (or lack of) to an area at another. Operating controls normally are duplicated on doors inside and outside the chamber, and emergency overrides usually are installed in the engineering section and at the engineering console on the bridge.

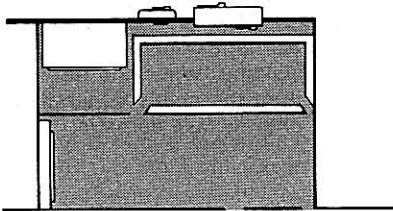

ARMORY

The ship's armory is a locked storage area for hand weapons. Only Command and Security personnel have the access codes for these rooms. Armories normally are located near transporter rooms (for landing party access) and brig.

BATTERIES

Batteries are large storage cells for power for use at a later time.

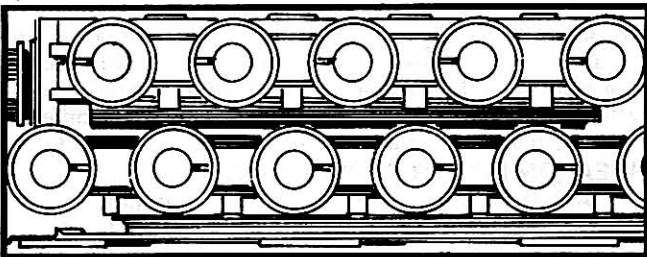

BEAM WEAPON

A beam weapon projects a beam of energy as its destructive force. The beam weapon of the UFP is the phaser, which is set to disintegrate. Ships of the Klingon Empire, Romulan Star Empire, and Orion Colonies use the disruptor, which vibrates cells and crystals until they lose integrity. The Gorn use blasters which project a beam of semi-coherent energy that damages through burning and cellular disruption.

BRIDGE

The bridge is the control center for a starship, where the Captain and duty officers monitor the ship's functions, steer the ship, and so forth.

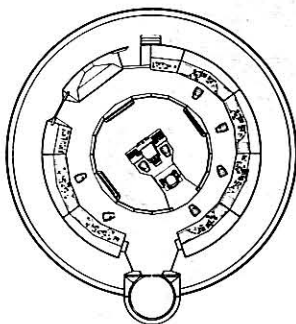

BRIEFING ROOM

A briefing room is a conference room normally used to brief (instruct) a group. This is where landing parties normally receive their instructions.

BRIG

The ship's brig is a detainment area used for holding or restraining personnel under arrest. When a brig is built aboard a ship, forcefield circuitry is built into the door openings to take the place of the older bars and locks. If a ship is too small to have a permanent brig, a cabin, a stateroom, or the sickbay frequently is fitted with a forcefield in addition to its normal door. If this is not the case, when needed, a competent engineer can rig a temporary forcefield in any room to take its place.

CABIN

On ships of the military, the Captain's quarters is called a cabin; on civilian vessels, the officers also have cabins. On yachts, couriers, and other passenger vessels, the passenger's quarters may be called cabins or, more commonly, staterooms.

CARGO HOLD

The cargo hold, or just hold, is an area specifically designed to hold cargo. It normally has various types of restraints to keep cargo in place, including straps, force fields, anti-grav units, and temporary walls. The capacity of a hold is measured in standard cargo units (SCU), which are a floor area 1.5 meters square by 3 meters tall.

CHAPEL

Though only the largest Federation military vessels have these, and some private or commercial vessels as well, the ship's chapel is used for services ranging from weddings to funerals. Most Romulan vessels are outfitted with chapels.

CHART ROOM

The chart room is a hold-over from the non-electronic/computer age. Although all navigational data is stored in the computers, the old naval tradition of a chart room is still strong in almost all cultures. This room contains hard copies of navigational charts and has equipment to reproduce charts and maps.

CLOAKING DEVICE

A device designed by the Romulans to render stationary ships invisible to the naked eye and to most visual sensors. The device is of less value if the ship moves, as its ion trail may be picked up on sensor scans set to detect it. The cloak is of no value if the ship uses weapons, because so much power is needed for the cloak that it must be turned off temporarily in order to fire weaponry.

COMPUTER, SHIP'S

The functions of most starships are computer controlled. There are several control computer types, each one capable of handling more or less of the demands of a particular set of shield generators, weaponry fire control sensors and targeting, and starship sensors. The larger and more complex the job demanded of a computer, the more advanced model is necessary to handle it.

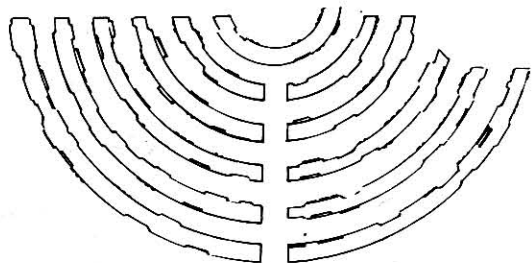

CONSOLE

The control panels used by the duty officers and crewmen in the bridge are called consoles. Some of these, such as the engineering and the weapons consoles, are repeater control panels showing the readouts for equipment located elsewhere.

Cloaking

Used to control the cloaking device, this console is found only on some Romulan or Klingon vessels, where it is often combined with the navigation console.

Command

This console is used by the officer of the watch or the ship's captain. Ship's log and communication/computer can be accessed here on most vessels.

Communications/Damage Control

This control panel handles all communications aboard the vessel, internal and external. Access to computer banks makes cross-reference possible for various forms of communications. Internal communications can be to almost any individual station or room. This console also monitors all damage control information, giving status of various compartments and crew casualties.

Engineering And Engineering Subsystems

All engineering systems are monitored here. All power generation and channeling may be controlled from here, though these controls are repeated in the engineering control room.

Environmental Systems

This console monitors all changes in atmosphere, gravity, and so forth. Any changes in the environment in any part of the vessel are made from here.

Helm

The helm handles the actual maneuvering of the vessel. On many vessels, particularly those of Star Fleet, this station also handles offensive weaponry.

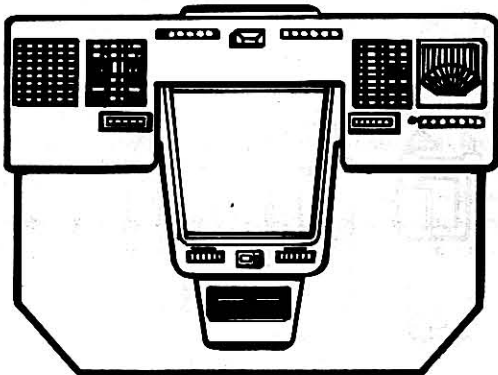

Navigation And Navigation Subsystems

These consoles control the computer that plots and carries out travel between destinations; it also handles the deflector shield controls. In larger vessels, this console works hand in hand with the helm, and on many smaller vessels helm and navigation are handled at the same console.

Sciences/Computer

The sciences console handles all sensor information received. Through its controls, data is analyzed, evaluated, and stored for later use, and data can be sent from this console to any terminal on board cleared and programmed to receive it.

Weapons And Weapons Subsystems

This console monitors all offensive weaponry systems. On more modern vessels, and on most Klingon vessels, this station rather than the helm console is the primary fire control center.

DECONTAMINATION ROOM

This room is used to decontaminate personnel or equipment.

DEFLECTOR SHIELD

The first line of defense of a starship is its deflector shield. An energy field that absorbs and dissipates the impact of other forms of energy or matter, or even minute quantities of anti-matter.

ENGINEERING CONTROL ROOM

The controls operating the engines, life support, and all other matters concerning power are located in the engineering control room, normally located adjacent to the engines. In most vessels, these controls are repeated on the engineering panel on the bridge.

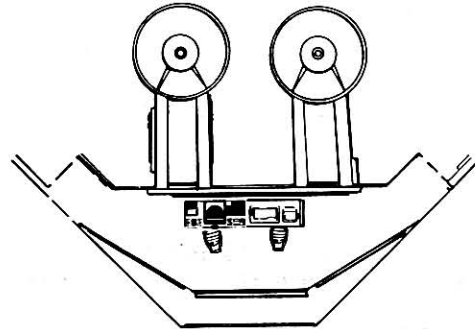

ENVIRONMENTAL SUIT LOCKER

Lockers for the storage of environmental suits, normally accommodating 10 suits, are kept unlocked. They are located throughout the vessel for easy access in an emergency.

FIRE CONTROL CENTER

Each of the ship's beam and missile weapons have a repeater console handling the firing of ship's weapons. The console ties into the computer for targeting and to the weapons console on the bridge. Although the bridge normally handles firing, the fire control center located near a weapons system is a backup in case the bridge is unable to fire the weapons. All firing is done through this console, even when the bridge is functional.

FOOD PROCESSOR

Food processors manufacture foodstuffs from basic protein, fat, carbohydrate, fiber, and nutrient supplies. These are reworked into textures, colors, and flavors that look and taste like freshly prepared meats, vegetables, and fruits. They can produce almost any type of meal from their memory banks.

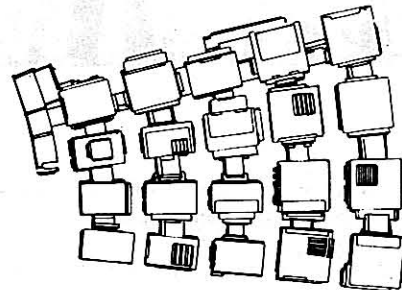

GALLEY

An old-fashioned kitchen called the galley allows the preparation of meals in a more mundane fashion, with stoves, ovens, and hand utensils. Maintained on many larger vessels, the galley is used by the crew to satisfy hobbies and exotic desires the processors cannot handle.

GYMNASIUM

The physical recreation facilities aboard many vessels include swimming pools, firing ranges, boxing arenas, and so forth.

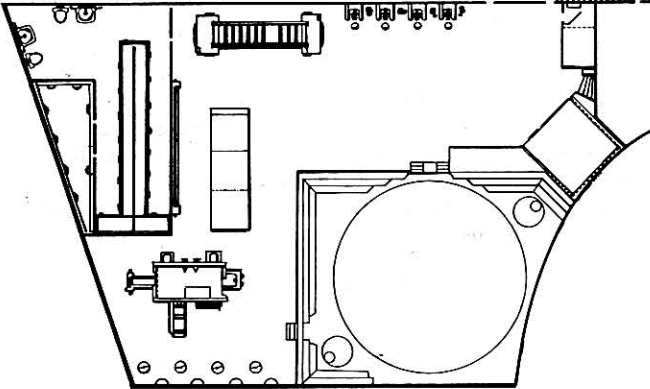

HEAD

Sanitary facilities aboard ship are of many types, be it the old Terran shower or tub to ultraviolet or sonic cleansing units.

HYPOTHERMIA CAPSULE

Hypothermia capsules are used by the Klingons to put combat troops into suspended animation; this process is called freeze-down. They save on life-support requirements for long journeys, but their reliability (98%) is low enough that they are not used by the UFP.

IMPULSE ENGINES

These engines are used for in-system maneuver. A variety of drive systems are used, including hydrogen fusion and directed ion pulses. For maximum safety, these engines require heavy shielding.

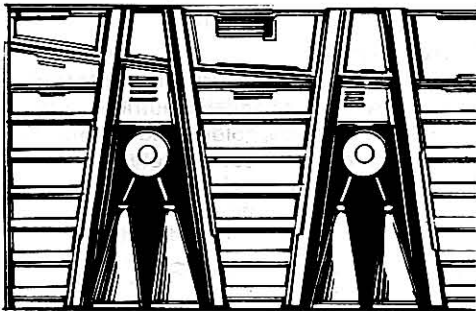

LABORATORY

Research facilities are quite extensive on most Federation vessels. These are of many types, depending on the mission of the ship. Included might be electronics labs for the study of all types of electronic-related fields, including radio, radar, and sensors. Life sciences labs are used for the study of botany and zoology. Medical labs may be used for medical research, be it a new disease or developing xenosurgical techniques. Physical and planetary science labs are used for the study of physical phenomena in space as well as of planetary and meteoritic or asteroidal bodies.

LAUNDRY

Although fabricators eliminate most uses for a laundry facility, there are many items of sentimental value which personnel wish not to have broken down and reconstructed. These small facilities are for such use.

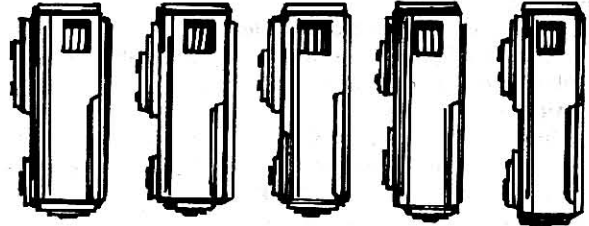

LIFE SUPPORT SYSTEM

The equipment necessary for the maintenance of life aboard the vessel, including water storage and plumbing, air conditioning and heating, atmosphere recirculation and revitalization, and so forth, is called its life support system. From the environmental or engineering consoles, the life systems in any room can be altered, controlled, or even shut down. It takes normally 2 to 5 minutes to change the environment in any room.

LOUNGES

Small recreational areas for the crew include reading consoles/chairs, game tables, viewscreens, food slots, and so forth.

MATERIAL FABRICATORS

There are four types of material fabricators aboard most ships: food, organic, metallic, and non-metallic. These devices take raw materials from storage and convert them quickly and in quantity to the desired items. This greatly reduces the need for the carrying of huge amounts of supplies, as raw materials are readily available everywhere for use in conversion. In addition, nothing is wasted aboard ship. All waste material is recycled in one way or another.

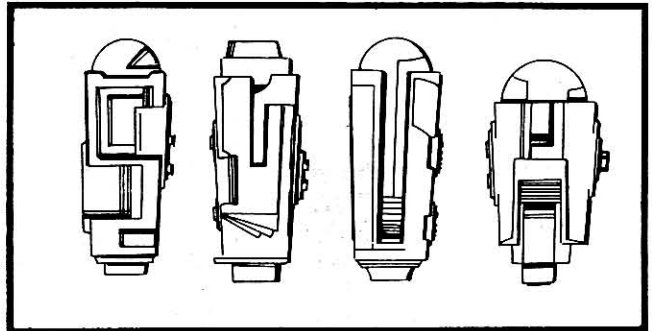

MEDIA CENTER

These are the libraries of the ship, although many times the library is contained in the ship's computer and the needed data or book is fed into the media chair, which resembles a chair with a computer monitor and keypad. Access to some data may be restricted.

MESSHALL

The messhall is the ship's dining facilities. These vary from a small table in a corner on a two man scout to the spacious facilities aboard a capital ship.

MISSILE WEAPON

These systems launch solid objects at their targets. In most modern applications, these objects are matter/anti-matter bombs called photon torpedoes. (see Photon Torpedo)

NACELLE

The nacelle is the superstructure that supports a warp engine and the hullmetal covering for it. There are two general types currently in use in the UFP, markedly different in outward appearance.

PHOTON TORPEDO

The heart of a photon torpedo is an encased bit of anti-matter. Fired from a torpedo tube, on impact the torpedo releases its enclosing magnetic field and it becomes a destructive fireball.

PLASMA WEAPON

This energy weapon of Romulan origin produces a bolt of white-hot plasma that is directed at its target by a tractor-pressor field. It is considered a missile weapon because of the semi-solid nature of the half-matter, half-energy bolt.

PYLON

This structural support member is used to hold warp engines a safe distance from the ship's hull. Most pylon assemblies contain devices that can separate the warp engines from the hull in case of a critical overload in the matter/anti-matter mix chambers or other emergency.

READY ROOM

A ready room, normally a conference room, is used to prepare a landing party and to store equipment such as translators.

RECREATION CENTER

The recreation center includes gymnasiums, media centers, and so forth. A unique Federation recreational facility is the holographic park area. Here any type of outdoor or indoor scene can be recreated so realistically that the viewer is not sure what is real and what is not.

SENSORS

Sensors are detection, sampling, and analysis devices used by starships to sample their environment.

SHIELD GENERATOR

Shield generators are used to make the defensive shield. The energy then flows through conduits to the 'webbing' on the outer hull.

SICKBAY

The medical facilities on a vessel can be quite simple, having one diagnostic bed with limited surgical facilities, or they can be quite elaborate and extensive, containing obstetrics, dental, psychiatry, and so forth. Larger vessels have sickbays with convalescent centers, intensive care, and more.

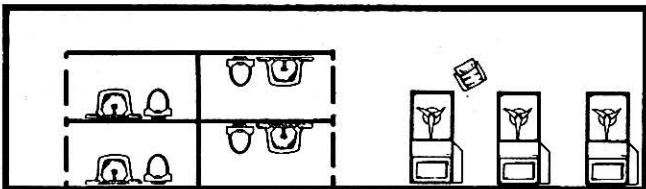

SHUTTLE BAY

The storage, launch, and recovery area for shuttles are often much larger than needed for the ship's own shuttles so as to accommodate shuttle from other vessels or planets.

STATEROOM

Living quarters for VIPs and passengers most often are called staterooms. Most Federation vessels are equipped with anti-grav plates for zero or low gee sleeping. Most are furnished with a work area, sanitary facilities, a small living area, a computer terminal, and so forth.

STORAGE LOCKER/COMPARTMENT

In addition to the cargo hold, every ship has various-sized storage facilities for gear, food, portable equipment, and other items that cannot be made by the material fabrication units for one reason or another.

SUPERSTRUCTURE

This is the all-inclusive term for the structural metal framework that holds the various ship components together and that defines its hull size and shape. Its strength may vary from ship to ship of the same size, depending on the amount of damage the vessel is intended to absorb. In general, the stronger the superstructure of a vessel, the greater its defensive abilities.

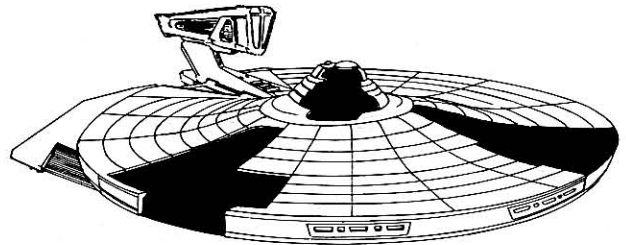

TRACTOR/PRESSOR BEAM

A tractor beam is an electromagnetic beam that allows a smaller mass item to be drawn to or pushed away from the vessel. Its maximum range is about 160,000 km.

TRANSPORTER

The transporter is a matter/energy scrambler capable of recording the molecular and sub-molecular pattern of an object, disintegrating that object, and beaming it across space to be reformed at another location as far away as 26,000 km. Both living and non-living matter may be transported as fast as the speed of light in this manner.

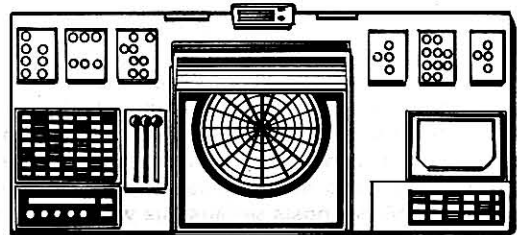

TURBOLIFT

High-speed, 10-man turboelevators are moved about magnetically through tubes running through the vessel. These are computer-controlled and voice-actuated; the user simply enters and tells the turbolift where he wishes to go, and the car takes him there in under 10 seconds.

WARDROOM

Some ships have a wardroom, which is used only by the officers for recreation and dining.

WARP ENGINE

This engine is powered by a controlled mixture of matter and anti-matter, directed through a dilithium crystal. The mixture produces a discontinuity in space called a warp envelope, which allows travel at rates that vastly exceed the speed of light.

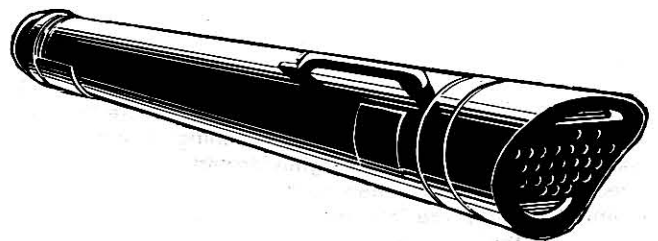

WEAPON MOUNTING HARDPOINT

These enclosures are used for mounting ship's weaponry. Each hardpoint includes all shielding and materials needed to properly accommodate the weapon.

COMBAT SHIP TYPES

Below are descriptions of each major type of combat vessel. Comments are included about the capabilities of each. They are listed from smallest to largest.

CUTTER

A cutter is a small patrol craft for in-system use; in Star Fleet, cutters are used by both Merchant Marine and Military Operations Commands. These vessels are lightly armed and shielded. Cutters are warp-capable, and their in-system maneuverability is very great.



GUNBOAT

This patrol craft is used for in-system, border, and other light patrol duty; its specialty is fast response to trouble-areas. In Star Fleet, gunboats are used by the Merchant Marine and Military Operations Commands to back up cutters while on in-system use, and they may contain sophisticated electronic surveillance gear for border duty. These vessels are lightly armed and shielded. Capable of greater warp speeds than the similarly-sized cutters, gunboats do not have quite the in-system maneuverability.



MONITOR

This gun platform is used in areas that are militarily sensitive; in Star Fleet, these vessels are used by the Military Operations Command only. Usually based in a newly-acquired area, they have a limited interstellar range because, if they are warp capable at all, they are capable of only low warp speeds. Because a monitor's mission is to dispel doubts concerning the ability to quell in-system civil disturbances, it has medium armament and light to medium shielding. Though it cannot stop most capital ships, it is used as a picket ship for border posts because its weapons can slow down warships before they get within range of the border post. It has the same in-system maneuverability as most capital ships.



COURIER

This vessel is designed for interstellar shuttle use, traveling from one known point to another. It is small and built for speed. Not intended as a warship, it has very light armament if it has any at all, and very light shields. Its main virtue is its speed, both in-system and at warp speed. Some, designed for VIP use, have luxurious passenger facilities. All Star Fleet Commands and other governmental agencies use these vessels. Outdated couriers frequently are refitted as private yachts or commercial freighters.



SCOUT

These ships precede research or military expeditions into an area, performing initial surveys in areas where "no man has gone before." Equipped for scanning, mapping, and exploring, these vessels are lightly armed and have light to medium shields. Most often used by the Galaxy Exploration Command, they are designed for long-range interstellar travel, and they have a lighter crew complement than other vessels their size. They have mid-range warp capability and moderate in-system maneuverability. Smaller scouts often are landing-capable, and thus they sometimes make the first contact with new races.



ESCORT

Designed specifically to provide armed escort for unarmed vessels, these ships have medium armament and shielding but sensitive electronic surveillance and monitoring equipment. Escorts travel in groups, always within transporter range of the vessels they protect, and thus they have only medium-range capability. In Star Fleet Merchant Marine and Military Command service, these vessels have sensitive motion detectors to combat Romulan cloaking devices. Lighter than the similarly-sized destroyers, these vessels have medium warp and sub-light maneuver capabilities.

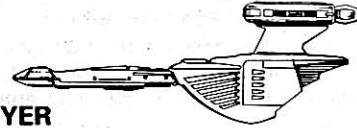

DESTROYER

The smallest capital ship, the destroyer is designed for extended, long-range military duty. The outer ring of defense, these ships are used on borders as patrol craft and surveillance monitors and in fleet support as picket ships at extended range. They are the least expensive warships that can be produced and be effective. They have medium armament and shields, and, like all capital ships, they are capable of medium to high warp speeds and medium sub-light maneuverability.



FRIGATE

This capital ship is used to protect a group of ships against larger enemy vessels. Frigates usually are deployed in small groups along sensitive borders. Frigates mount heavy firepower and carry troops in some configurations. They have medium to heavy shields, and are capable of medium to high warp speed and medium to fast sub-light maneuverability.

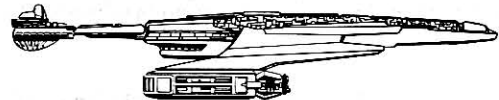

CRUISER

These capital ships are used to protect a group of ships against larger enemy vessels. When used in this role, they are accompanied by destroyers. Cruisers also serve as research vessels. All contain extensive laboratory and computer facilities. They are deployed mainly in non-sensitive frontier areas following up scouting reports. They have medium to heavy armament and shields, and are generally capable of high warp speeds and medium to fast sub-light maneuverability.

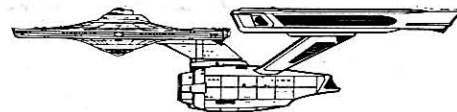

BATTLESHIP

This is the largest capital ship, the most heavily armed in the fleet. Used as fleet flagships, battleships provide awesome firepower from behind their defensive screen of destroyers and frigates. They also are used for planetary bombardment. They have heavy armament and shields, and are generally capable of high warp speeds.



COMMERCIAL AND NON-COMBAT VESSEL TYPES

FREIGHTER

Freighters are used to carry freight inside their hull. Their speed and maneuver characteristics depend on the load that they are carrying at any moment. Usually mounting engines that can move exceedingly heavy loads, these vessels are among the largest, slowest, and least maneuverable starfaring vessels. Depending on the area to which they are assigned, they may carry light defense shields in addition to their navigational deflectors.

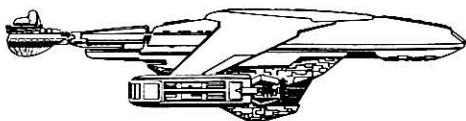

LINER

Liners are used for commercial passenger transport on specific runs, such as from Vulcan to Terra, or on exotic cruises, such as sightseeing tours in the Goran Nebula. They frequently have a wide range of accommodations, from the most luxurious to the most spartan. They have navigational shields and are capable of slow to medium warp speeds and medium sub-light maneuverability.

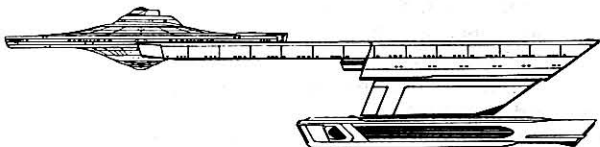

REPAIR FACILITY

These 'dry docks' are used to build and repair ships in space. Some are warp capable themselves, but most are towed into place or constructed where they are needed. Resembling a gigantic bird-cage, they are largely framework structures. A notable exception is the Space Dock that orbits Terra, which has entirely internal repair/construction facilities. These structures are not armed by the UFP, but the Romulans and the Klingons use them in forward areas, and thus arm them.

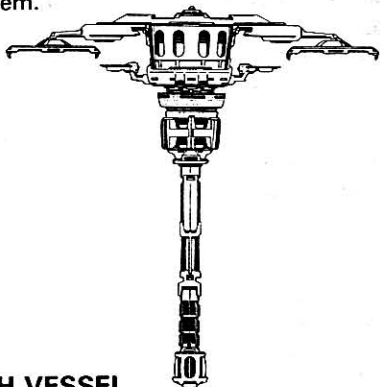

RESEARCH VESSEL

These ships are used for scientific research only. Those under Star Fleet control are required by regulations to carry at least one weapon for protection. They have generous laboratory facilities and larger, more-powerful computers than would be expected on warships of comparable size.

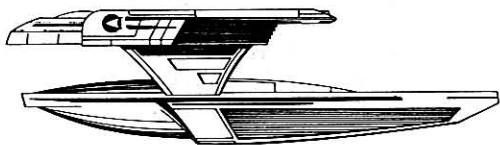

SHUTTLECRAFT

These sub-light craft are capable of atmospheric landings. They are used, in place of transporters, to move small groups of personnel about. They also function as ship launches and as lifeboats.

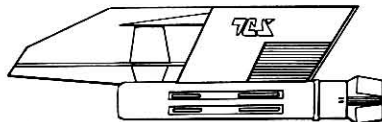

TRANSPORT, COMMERCIAL

Called tugs, pushers, or pullers, these vessels move their cargo around in pods, either pushing or pulling it, much like the railroad engines of early Terran history or the tugboats that plied its waterways. Essentially a framework for holding oft-times enormous warp engines, they have minimal shielding and weaponry. They have slow to medium warp and maneuver capabilities.

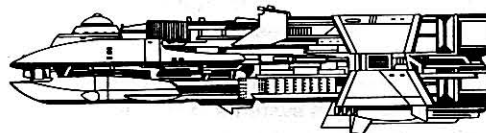

TRANSPORT, TROOP

These vessels, sometimes called assault ships, are used to move troops. Most have large numbers of combat transporters and small and large cargo transporters. They may have light to medium armament and medium shields, and they are capable of medium to high warp speeds.

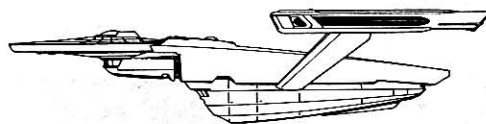

WARPSHUTTLE

This is a warp engine with capability to move people about.



YACHT

These pleasure and luxury craft are the private sector equivalent of the scout or courier. They have various shield capabilities for their mass (generally Class I or II), and may mount small beam weapons. They have medium to high warp capability, and high sub-light maneuver capability.

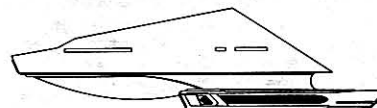

Equipment Descriptions

Federation equipment comes from a variety of manufacturers. As can be imagined, there are over one million separate parts catalogued in Star Fleet Quartermaster listings. From the mighty warp engines down to the smallest bolt, every ship part in the Federation is given a parts number by the Materiel Command. Official Star Fleet parts are not the only ones catalogued; every known ship part, government or private, are cross-referenced by manufacturer, procurement center availability, substitution possibilities, prices, and so on. Fortunately, sophisticated computer programs make this manageable.

It is beyond the scope of this manual to deal with all the possible parts that make up a starship. Instead, only the major systems are covered here, including control and guidance systems, propulsion and power systems, deflector shield systems, weapon systems, and superstructure and support systems. Little will be found here on what the systems do or how they perform; that is left to other reference works. What is given, however, is information on manufacturers, design notes, historical notes, and miscellaneous facts pertaining to the system.

Even though only a few corporations seem to dominate all construction of ship's systems in the UFP, many subcontractors are used. Also, many systems are licensed to other corporations for construction. So even though the FWA-1 engine may have been designed by Shuvinaaljis Warp Technologies, a particular FWA-1 engine may have been built by Johansen Industries.

System Type Designations

Type designations were not assigned to ship components until Stardate 2/00. Therefore, many early systems may have capabilities that seem out of place" when looking at their letter code designations. For example, the FWH warp engine was in use two years earlier than the FWA-1. Please keep in mind that alpha position does not mean design or use position.

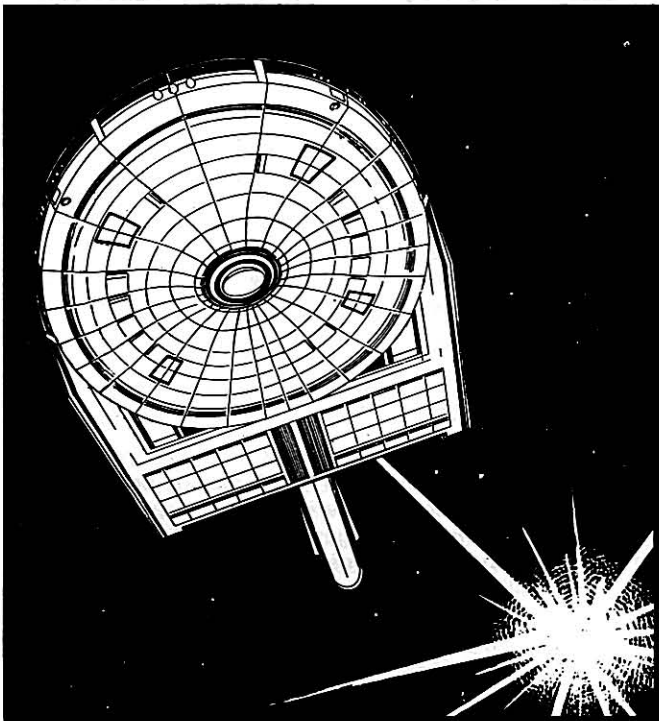

CONTROL AND GUIDANCE SYSTEMS

COMPUTERS

Computers have been used from the beginnings of space travel to control all of a starship's functions. Just as the discovery of Dilithium was vital to the development of current warp technology, however, something just as vital occurred in computer development. Most other ship technology advancement was dependent on the development of the M series of computers. This development was not without its incidents, as will be seen.

L Series

Early models, such as the L-1 through L-11 are not in general use at this time. Historical works, such as the standard *Historical Development Of The Starship*, by D.T. Poole, cover these items and other similar early developments no longer in service and thus not appropriate for this work.

Shiputer Corporation's L-12 computer is significant because it allowed the FIA engine to be used. Until the L-12's development, the control of the the new breed of impulse engines, represented first by the FIA series, was tricky at best and impossible under heavy load conditions.

The L-13 is slightly more powerful than the L-12 but not much different in most respects. Designed and constructed by Perandis CompWorks, it came out almost at the same time as the FIA warp engine, but because the FIA had been designed for the L-12, the L-13 was not widely accepted for several years while Perandis looked elsewhere to find a system to help them sell their design.

Though the L-14 was designed by Shiputer Corporation to operate the FSG shield defense system, it eventually saw wide-spread use in vessels designed to operate other systems as well. Its reliability became an industry standard, and Shiputer's reputation soared.

In Stardate 1/75, a new computer company was formed that has come to dominate shipboard computer systems. The head designer and owner of Daystrom Data Concepts was Dr. Randall L. Daystrom, the father of the now infamous Dr. Richard Daystrom.

The development of the M-1 computer ushered in a new era of astronautics: constructions including new warp engines using dilithium crystals. The later development of the M-2 allowed for the development of the second generation of warp technology, the FWB engines.

After this, computer development and warp engine development seemed to be tied together, and so it was no surprise when the M-3 computer and the FWC warp engine were developed jointly at an immense Earth orbital construction/research center owned jointly by Shuvinaaljis Warp Technologies and Daystrom Data Concepts. The M-3 was very successful, but early models had a tendency to crash in the middle of a warp program. The M-4 was the last successful computer designed by Randall Daystrom. Its development allowed for the development of the FWC-2 engine for tandem drive vessels.

Richard Daystrom took over Daystrom Data Concepts when his father died in 1.93. He embarked on a research project that ended in total failure – the M-5 Duotronic computer. The M-5 was designed using Daystrom's mind patterns for the thought patterns of the program, a design concept with great possibilities, except that Daystrom was mentally

unbalanced. The M-5 was destroyed after it had wreaked much havoc upon its testers, and similar work has been banned.

In the latter half of 2/0900, the M-6 computer became operational. This computer was designed by the Daystrom corporation, which survived the death of its founder and son, as most large corporations tend to do. The development of the M-6 was vital to the development of the powerful FWG engines, indicating a return to the coordination between warp technology and computer technology.

PROPULSION AND POWER SYSTEMS

There are currently six categories of starship propulsion and power systems in Federation inventories. These include warp engines, the experimental transwarp engine, micro-warp engines, impulse engines, sub-light engines, and power generators.

WARP ENGINES

Warp engines produce power through the controlled annihilation of a delicately balanced mixture of matter with antimatter. This power is used to propel a star vessel at faster-than-light speeds, and the excess is diverted to the ship's power grid for distribution to most of the ship's other systems. It was this invention by the Alpha Centauran scientist Zephram Cochrane in roughly 0/4812 that led to the exploration of the stars.

In 0/6511, when the Vulcans were encountered, it was discovered that they, too, had a warp drive. Both designs were roughly compatible, and a much improved version evolved. Many different warp drives were designed over the next hundred years or so, but most of these were limited to vessels of Class IV or smaller, and maximum speeds were lucky to reach Warp 5.

One of the largest problems faced was control of the power systems. None of the L Series computers could handle the immense speeds needed to process the data fast enough for the larger matter anti-matter reactions in tandem-engined vessels. Though the technology existed as early as 1/5000 to design and build faster engines, not until 1/7910, when the M-1 computer became operational, did it exist to operate them. The M-1 had the capability to handle cruising speeds of Warp 5 on Class II to IV tandem-engined vessels with emergency speeds of up to Warp 6.

Most scientists working with warp power systems felt that the maximum warp speed would be increased even more with the use of the M-1 computer, and an improved model of the FWH-1 was ready to be tested before the FWH-1 model even went into full production. This engine, the XFWH-2, was designed for speeds up to an incredible, (at the time) Warp 8. The M-1 could not process the data fast enough, though, so the design was shelved. Fortunately, Daystrom Data Concepts Inc. was already hard at work at advancing the M-1 series farther, and subsequent events would complete the link between computer development and warp drive control technology. When the M-2 computer became operational, the data processing speeds being looked for were attained, and warp engines again pushed the computer's design limits.

FWA-1, FWB-1

The design differences between the FWA and FWB engines were minor. The FWA was designed for vessels of up to Class III, whereas the FWB could be used on vessels up to and including Class VI. The imaginary Warp 8 was not only attained, it was surpassed on small vessels equipped with one FWA-1. On Stardate 1/8211.17, the *USS Jasokhe*, a Class II research ship set a new speed record of Warp 9.346. The vessel's Vulcan pilot, Captain S'Loatta, was heard to remark that it was only logical that the vessel travel at the record speed because "the equations dictated that it would." The same stoic Captain later remarked that speeds of Warp 10 were impossible because research showed that the data handling capabilities needed were unattainable.

FWC-1

Toward the end of Stardate 1/85, Captain S'Loatta was to be proven wrong by the advent of the M-3 computer control system. Surprisingly enough, it was not Shuvinaaljij Warp Technologies that designed the next stage of warp engines.

The UFP had decided 10 years earlier that the stagnation in warp technology might be cleared up by encouraging competition in the power industry. Low-interest loans were made available to corporations (not individuals) who could prove they were capable of generating designs and handling production techniques. Only after the loans were announced in a widely publicized press conference did the UFP discover that only Shuvinaaljij Warp Technologies had the know-how to build warp engines, let alone make design advances.

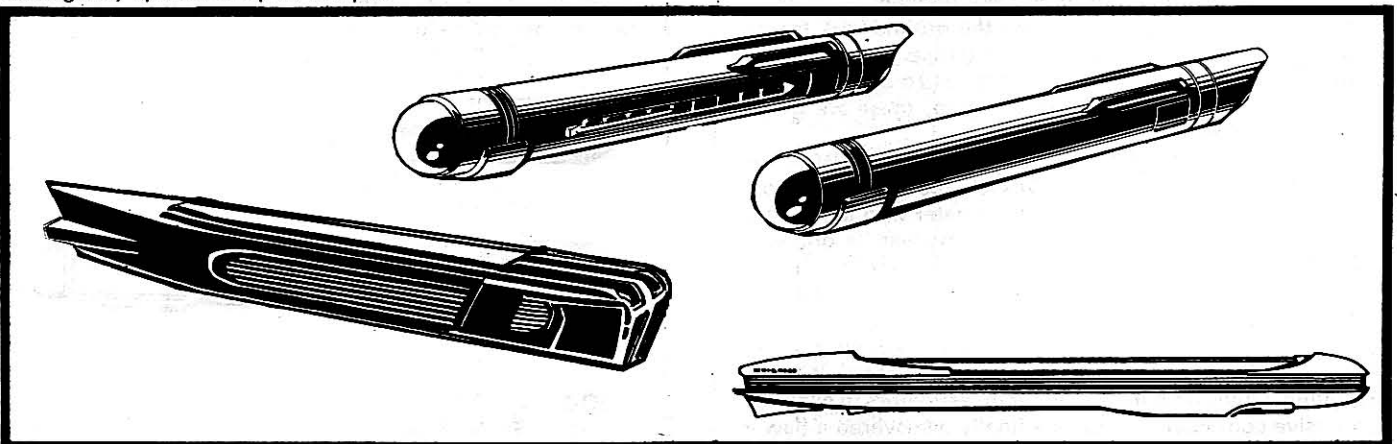

FWH-1

Two astonishing months after the release of the M-1 computer, Shuvinaaljij Warp Technologies of Vulcan had the FWH-1 warp engine operational, and it was in production after only six months of trials. To this day, Shuvinaaljij remains a leader in warp engine design.

Shortly afterwards, Dr. Harold S. Leedstrom, a scientist once fired from Shuvinaaljij, set up shop on his own, taking out the first of the much-touted government loans and proving that the idea was not the boondoggle the press had made it out to be. While working at Shuvinaaljij for a number of years, Leedstrom became convinced that he could break

the Warp 10 barrier. His superiors could not contend with his haughty attitude and fired him. He promptly gathered others who were disgruntled with their present employer, formed a corporation, and took out the loan. His entire design team from Shuvinaaljis joined him and eventually formed the core of Leeding Engines Ltd.

They formed a good working relationship with Daystrom Data Concepts, and so they were given the first crack at the M-3. They had the engines ready when the computer became operational; the FWC was designed to deliver 25% to 35% more power to combat systems than any previous engine. On the *USS K'Ree*, a large (for its time) Star Fleet vessel turned over to Leeding Engines for research purposes and modified for the test, Leedstrom mounted a single experimental FWC engine. Captain Joshua Abrams, who took the vessel out for a trial run of 45 days, surprised everyone by turning in a cruising speed of W8 and an emergency speed of W10.

In later years, Leedstrom also formed a good working relationship with Chandley works. The FWC-1 was used on the popular *Chandley* Class vessel.

FWD-1, FWE-1

Shuvinaaljis Warp Technologies responded to the challenge with an engine using the M-2. Their design, the FWD engine, could handle relatively large vessels at good speeds. Its major advance was in the stress the engines could handle on the larger vessels.

The competition between Shuvinaaljis Warp Technologies and Leeding Engines Ltd. intensified to the point of corporate warfare. Rumors of piracy and theft from corporate vaults circulated widely; later, many were found to be true, and both corporations have since been found guilty of criminal acts. Research personnel were found dead in their offices at Leeding, which only intensified the warfare until Leedstrom was found dead at home, a small pistol in his hand. Foul play was never proven, and to this day no one is sure whether or not Leedstrom committed suicide or was the victim of a very elaborate plot.

The FWE was the last engine to bear his personal imprint. Not only could it use the old M-1 computer, but it also enabled even larger vessels to be built. For the first time the Federation was capable of building a vessel of over 180,000 mt.

FWA-2

In 1/9100 Shuvinaaljis Warp Technologies adapted the L-13 and M-1 computers to their FWA engines, from which a new model was derived, setting the groundwork for the redesign of all engines produced to that time. The new model retained the FWA classification, with the old model becoming the Mark 1 and the new the Mark 2; today these are known as the FWA-1 and the FWA-2.

With modifications to the basic design, the FWA-2 engines could be used on larger vessels than the old model. Although the warp speeds were no greater with the FWA-2, the power generated for combat systems was. In one way, the FWA-2 was a step backwards, as the stress the engines could handle was not as great as the FWA-1 could, and overall maneuverability was not as great.

The engine design fell under a cloud when the first test ship exploded during trials pushing the engines to W9. The resulting explosion left nothing for investigators to examine. Extensive computer simulations finally discovered a flaw in the computer programming, and the engine was cleared for general use.

FWC-2

One year later, in 1/9200, Leeding Engines Ltd. adapted their FWC engine to use M Series computers on single-engined vessels. As with the FWA modification a year earlier, the original model became the Mark 1, and the new derivation became the Mark 2; now these are the FWC-1 and FWC-2 engines.

Although it seemed a needless expense by many, once the system had been tested the doubters were silenced. The high speeds expected were not attained; in fact, the speeds were slower. Though stress tolerances were slightly better, the overall reliability of the engine system suffered. Overriding all of the disadvantages, however, the power increase was astonishing, with roughly 50% more power being coaxed from the engine.

After initial tests on single engine vessels, Leeding acquired the new M-4 computer from Daystrom Data Concepts, becoming the first manufacturer to use the M-4. They used it to control tandem FWC-2 warp engines in production vessels. Again, the size of vessel was limited compared to those available with tandem FWC-1s, but the power output was increased about 40%.

FWE-2

With the advent of the Four Years War, the UFP had such dire needs for warp engines that research almost halted in favor of expanded production. Normally in a war, research expands and technological advances take place over night, but the Four Years War was an exception to that centuries-old rule. Because the construction of warp engines was controlled by so few corporations, every person was needed to expand construction facilities. Because the technology required to produce warp engines is more advanced than nearly all other industries, scientists and research personnel are required just to build the warp engine construction facilities and oversee their operation.

Although research slowed, it did not stop. Shortly after the Four Years War, Leeding Engines Ltd. produced the Mark 2 FWE. Again, the upgrade did not produce any upgrade in speeds, but the power production was stepped up. The Mark 2, now known as the FWE-2, was, however, controllable by an L-Series computer, the L-13 on the single engine models.

FWF-1

The FWF (now the FWF-1) from Shuvinaaljis Warp Technologies used M Series computers for both single and tandem applications. Its speeds were not as great as on many previous designs, but the stress capabilities were excellent. Though power capabilities were also very good on the large vessels these engines could handle, maneuvering was poorer than had been normal.

The FWF-1 is noted for its use on the *Constitution* Class vessel, proving to be very reliable and sturdy on their 5-year missions. The stories of the punishment these engines could take border on the unbelievable.

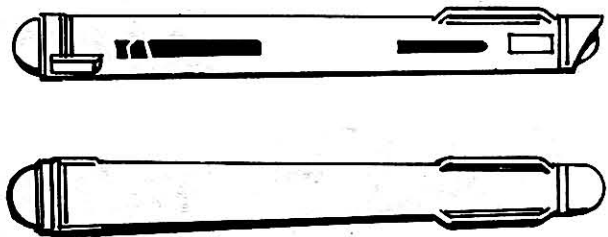

FWD-2

The FWD-2 modification of Shuvinaaljis Warp Technologies' FWD engine is most noted for a slight flaw that reduces the stress that it can take compared to its contemporaries. Again, power to combat systems was upgraded at the expense of other design considerations.

Production of this engine was delayed for three months when the main assembly line on *Genoa VI* blew up. Investigations into the explosions revealed sabotage, but no real leads ever surfaced to prove the rumors that Leeding was responsible.

FWB-2

The FWB-2 was an update of the older-style FWB engine constructed by Shuvinaaljis Warp Technologies. At first glance, this engine definitely appeared to be a step back, as its characteristics seem to be worse than the model from which it evolved. The power gain was significant, however, and the resulting maneuvering capabilities made the changes worthwhile. By the time this engine was in production, demand had increased to such proportions that this engine was the first to be constructed in numbers greater than 25,000. Though earlier engine types later exceeded this number, the FWB-2 was the first type to exceed 25,000 in continuous production.

FWG-1

The FWG-1, the latest in warp engine design, was the first real advance in warp engine design in many years. Surprisingly, it was not a Shuvinaaljis Warp Technologies design, but a Leeding Engines Ltd. design. They had modified engines over the years, but this was the first from-the-ground-up design they had offered in 22 years. Nevertheless, this engine has led to speculation that Leeding may emerge as the dominating force in warp drive production, with the experimental transwarp engine being developed by Shuvinaaljis Warp Technologies seen as the only hope that Leeding's rival has of keeping pace.

The FWG-1 was the first engine that could handle vessels over 270,000 mt. It offered excellent stress characteristics, and the power it sent to combat systems was outstanding. It was designed to the use of the M-6 computer, the first usable computer advance in 18 years.



TRANSWARP ENGINES

Currently, the FTWA is the only transwarp engine model in existence, and only two of these are operational. Shuvinaaljis Warp Technologies, the designer of this revolutionary new engine type, has been extremely reluctant to reveal the technology behind the engines, giving rise to great speculation as to how the FTWA works. Some say that even the scientists who built it are not sure.

What is known is that the engines and the new transporters work in tandem. Basically, the ship puts a transporter field around the ship's engines, which have the ability to use this field in conjunction with the warp envelope, with the ship in effect beaming itself ahead in the envelope. As long

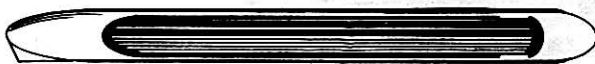

as the transporter field is activated the ship can attain phenomenal speeds, reaching Warp 15 in an emergency, and cruising at Warp 14. Though the transporter technology is reported to be similar to that of standard personnel or cargo transporters, the field generator mounted in the engine nacelles is much larger than has ever been constructed.

The two operational engines have been mounted on the *USS Excelsior*. The vessel has only had one trial run to date, that being its unplanned and unsuccessful pursuit of the *USS Enterprise*. Even if sabotage had not been performed on the engine control system, functioning was not assured as the engines had not yet been tested on the vessel, which had only been recently towed to the Space Dock. The projected power output indicates that, if the vessel is successful, it could change the course of Federation - Klingon/Romulan relations, the possible weapons usage and maneuverability theoretically tremendous.

MICROWARP ENGINES

There is only one microwarp engine design in use today, the FMWA. Produced by Shuvinaaljis Warp Technologies in Stardate 2/1200, the engine filled a hole long left open. For many years, the only way to move a few people or small amounts of valuable cargo was aboard a full-size ship, such as the *Mission Class II* courier. The expense of building and operating such a vessel was prohibitive to all but the most vital of transportation missions.

One day Shuvinaaljis scientist Paul Anders was riding in a small shuttlecraft between an orbital construction site and his planet-side home when an idea came to him. He reasoned that if he could mount miniature warp engines on the shuttle, he could cut inter-planetary system costs by a very large percentage. Though he knew that miniature warp engines were considered to be something existing only in science fiction novels, he took a thirteen-month leave of absence from his regular duties to work on the idea. What evolved was the FMWA.

Current technology does not foresee any advancement in design of microwarps, so the Shuvinaaljis basically has a monopoly on the engine. Leeding's microwarp has only cosmetic changes, its operating statistics remaining the same.

IMPULSE ENGINES

Impulse engines are reaction thrusters used to drive a ship at near-light speed for in-system maneuvering. The excess power can be diverted as the power from the warp drives is.

Many attempts have been made to use tandem impulse drives on vessels. For some unknown reason, whenever the tandem engines are activated, the warp drives refuse to work. It seems likely that the use of two impulse drives at the same time in such a small area creates a magnetic disturbance that causes an imbalance in the matter/antimatter reaction.

FIA

In 1/7600, Smith & Smythe Motor Works, Ltd. put into production the first mass-produced impulse engine. Although many different types of reaction drives were used previously, the FIA was the first engine to be used in quantity on UFP military vessels. It was useful only on vessels up to Class III, however, severely limiting the size of vessel that the UFP could field.

The FIA was produced in three configurations, Marks 1 through 3; now known as the FIA-1, FIA-2, and FIA-3, these produced varying amounts of power usable for ships of different classes. This versatility set the standard for all impulse engines that followed, though some were found to have the same maneuver efficiency characteristics and thus are little used.

FIB

In 1/8100, Smith produced the FIB to meet the demands for an engine to be used on larger vessels. The FIB is perhaps the biggest failure among impulse engines. Of modest power, it was hoped that it could be used as widely as the FIA series, but this was not to be. The first time the engine was tested it created a disturbance in the vessel that literally shook the vessel apart. Fortunately, a quick-eyed engineer spotted the problem immediately and shut the engine down. This was just the beginning.

The FIB-2, the worst of the three models, was found to be completely unstable except in one configuration: on the *Larson Class VII Destroyer*. It has been removed from service in all other uses, where its reliability is so low (D) that its maintenance costs are prohibitive.

The FIB can be replaced with the FID in most uses, delivering more total power for the same movement efficiency.

FIC

Because of the failure of the FIB, the demand for engines to handle larger vessels still remained. Nine years after the introduction of the FIB, a new company, Kloratis Drives, began to market the FIC impulse engine, which could handle Class XI ships, a new record. All three configurations are successful.

FID

Engine development continued at a moderate pace. The FID, built by Smith & Smythe, was in development during the Four Years War, but did not see production until the war had ended. The FID, capable of handling up to Class XV vessels, was the first impulse engine to be extensively licensed for production around the UFP. It marked a plateau in impulse engine design that continued for twelve years after its introduction.

FIE, FIF

A breakthrough in design allowed the FIE to be hooked up to an M-1 computer, giving a tremendous increase in power capabilities. The power output was double the FID in most cases. Designed by Kloratis, it enabled them to dominate the impulse market for almost five and a half years until the introduction of the FIF models.

Designed by S & S, the FIF took the best qualities of the FIE and improved upon them. When first released, Kloratis sued S & S over patent and copyright infringements. But when it turned out they had illegally used many of S & S's systems in the FIE, they quickly worked out a mutually satisfying agreement.

FIG

The FIG is the most recent entry in the impulse market. Designed by Kloratis, it is currently not selling very well. Designed to handle very large vessels, the system can really crank out the power. However, the system is being plagued by malfunction after malfunction. At this time, the engine has gone into limited production. The first 175 off the assembly line have been recalled in an attempt to correct many of the problems.

FMIA

In 2/0900, S & S released the FMIA, the first micro-impulse engine. It was the advent of this engine which spurred research into micro-warp technology. The engine has proven to be extremely reliable in the field, leading some to say it is the best engine on the market of any size.

DEFLECTOR SHIELD SYSTEMS

Deflector shield systems are more commonly referred to simply as shields. Many people new to ship system technologies do not realize there are two general types of shields. The first type is known as navigational deflectors, the second as defense shields.

NAVIGATIONAL DEFLECTORS

Navigational deflectors are common to all vessels that ply the spaceways. In the early days of in-system travel vessels were not equipped with navigational deflectors of any type. They naturally took quite a beating from micro-meteorites, meteorites, small asteroids, and other space debris. Large obstacles could normally be avoided, given enough notice, but small objects were difficult to detect in time.

Scientists searched for a way to destroy the objects before they hit the ship. They looked back to Terra's late 20th- and early 21st-century so-called 'Star Wars' defensive systems. At this stage, it must be remembered, Terra had not yet developed space travel aside from visiting their own moon a few times. Nonetheless, systems had been developed to defend the nations from each others' ground-to-ground, long-range missile systems. In the late 20th century, the United States had the foresight to develop a way to destroy enemy missiles before they had the chance to re-enter the Earth's atmosphere. Many of these systems, built on platforms in orbit, are considered the forerunners of today's Monitors and other system defense vessels.

From the defense systems sprang the idea of defending installations at ground level with energy shields. Early shields were very small, usually protecting an area not more than a hundred meters across, an area that was not to grow in size for roughly another 150 years. When space travel became a reality, however, small shields were just what was needed. With the advances in power sources, computer systems, and miniaturization, astronautics firms were able to adapt these systems to their starship designs.

Thus, small navigational deflectors have basically remained unchanged to this day. There are minor variations, of course, but all ships of all cultures carry the same basic systems. Most navigational deflectors protect areas that are the same size, requiring several to cover a large vessel. The differences in the deflector systems used by the Federation are largely cosmetic, and the navigational deflector system usually is purchased with the defense shield system.

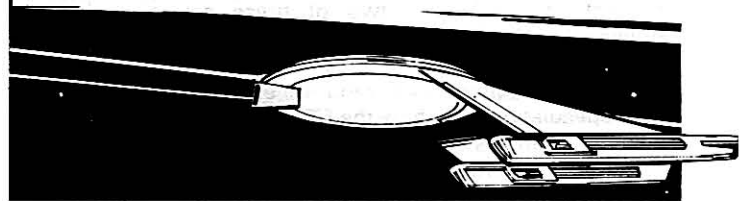

DEFENSE SHIELDS

After many years of relatively peaceful space travel, conflict between vessels required defenses be built on starships. Ways of trying to increase the power of navigational deflectors to defend vessels became a research priority. The ways and means of early space combat were extensive, though

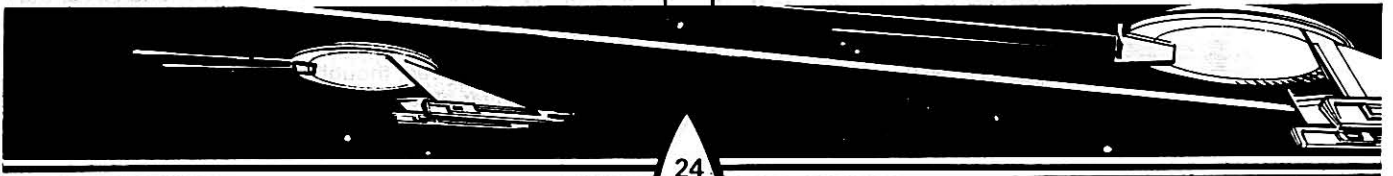

much of the equipment used, even in the Romulan War, would be considered almost comical today. After the war, research was stepped up to an intensity never seen before, but still it took 50 years before a breakthrough was finally achieved.

As is often the case when a new weapon system is developed, developers also seek ways to defend against it. At the same time that the FL-1 laser was being developed, research was feverish following a recent breakthrough in navigational deflector technology. A way had been found to increase the power to navigational deflectors so that they could protect against larger objects. Until this time, deflectors had a tendency to buckle the hull when power was increased.

With the breakthrough, an energy transformer stepped up the power levels being sent through the deflectors without buckling the hull, and gave an interesting side effect. Protection could be extended farther out from the ship, and a new control system allowed the energy to be channeled in any direction desired. This directional ability worked so well that part of the system could protect the hull surface a different intensity than the deflectors. The company responsible for this amazing discovery was Landauer Space Dynamics Inc. of Terra.

Thus, the defense shield became a reality. It did not take long for the military mind to realize that with the directional abilities the system could now be adapted to use on planet-side bases as well as ships and outposts in space.

FSA

On Stardate 1/79, Landauer SysTech Ltd. released the first defense shield generator that made use of their earlier breakthrough in energy transformer technology. Their Mark 1 Defense Shield, now termed the FSA Shield Generator System, was an instant commercial success. Spurred on by the influx of usable cash, and unable to match production to the demand, Landauer expanded its operations, gearing up several new production facilities per year for the next 5 years.

Dr. Randolph Webbe, the inventive genius responsible for the new transformer, was given free reign and virtually unlimited credits for research and development, and work was begun almost immediately on a new transformer design that was to result in the Mark X Double Phase-Shift Transformer in 1/85.

FSC

Backed by the immense personal wealth of H. R. Charlottes, a company headed by Dr. Elizabeth Charlottes released its version of the Webbe shield in 1/83, overpowering Landauer in a bitter litigation involving supposed irregularities in registering Landauer's formerly exclusive design. This shield used the Webbe single phase-shift transformer of the FSA, but modifications to the original design gave it slightly more output power.

FSE

In 1/84, also backed by enormous wealth, Surelox Systems, a branch of the Leeper-Fell industrial conglomerate, enters the defense shield marketplace with yet another pirate of the Webbe system. Its low-power, single phase-shift transformer gave it only marginal advances in defense capabilities, but the FSE established Surelox as a major contender.

FSG

Charlottes Shields, Inc., released this up-powered version of the FSC in 1/86, in a bid to capture the market. With its maximum shield power of 15, it was speculated that the single-phase transformer had been pushed to the limit with this shield generator. With its release, Charlottes gained the upper hand in this very competitive market, though it was not to keep this position long.

FSB, FSD, FSF, FSH

On 1/8705.21, a trembling Dr. Randolph Webbe announced a major breakthrough in defense shield technology, revealing a working prototype of his double phase-shift transformer. This breakthrough, cloaked for three years in complete secrecy while all bugs were ironed out, gave twice the defensive shielding for the power. It was matched to Landauer's Mark 1 system to create the Mark 2. In this one brilliant research stroke, Landauer, overextended because of unexpected competition from the Charlottes and Surelox systems, regained its initial lead.

Stung by Landauer's marketing coup, and bolstered by its precedent-setting litigation with the Webbe single-phase transformer, Charlottes Shields introduced their own systems upgrades with the simultaneous introduction of their Mark Ia and Mark IIa systems. Using the double phase-shift transformer, declared by the Federation courts to be in the public domain (speculation about high-level pay-offs was never proven), the Charlottes Marks I and II were more powerful than the new Landauer Shield. Now dubbed the FSD and FSH deflector shield generators, these systems are said to be responsible for Landauer's subsequent collapse.

Keeping pace with the other companies and riding on the coat-tails of the legal precedents set by Charlottes Shields, Surelox upgrade its Model A system with the new double phase-shift technology. Now known as the FSF, their new system, introduced 1/90, allowed them to remain marginally competitive.

FSI

In 1/89, when Landauer realized that Charlottes Shields had a virtual strangle-hold on first place in the shields market, it fired its chief executive, William Wyandotte. Backed privately, Wyandotte lured several members of the Landauer design team to join him in a speculative research venture. In 1/91 they pioneered the trinary transducer system that turned the single phase-shift energy transformer into a high-powered shield generator, delivering three times as much shielding for any given amount of power. Furthermore, the new system proved that the old maximum shield power limit of 15 could be extended to 16.

Forming Wyandotte Defense Shields Corp. to produce the new generators, they leap into the marketplace, nearly eclipsing the others, despite the reliability drawbacks their generator suffered. Because the shield gave useful shielding capabilities to larger vessels, the Wyandotte DS1 (now known as the FSI) was bought in numbers disproportionate to its state of development. It was not until 2/04 that the FSI's reliability reached the level of the earlier-model shield systems.

FSJ, FSK

In a desperate bid to recapture their share of the market, Landauer launched an all-out effort to upgrade their Mark 1 system to be the first generator to deliver the full maximum shield power of 16. Their Mark 3, designated the FSJ, was to be the undercapitalized and over-extended industry founder's downfall, and on 1/9404.27 the company went into receivership.

Drawing on its parent company's reserves, Surelox purchased controlling interest, paid off all debts, and took over production of all the Landauer shield models, including the FSA and FSB. It geared up production of the FSJ as well, also producing the FSK double phase-shift model. This gave them a solid base for sustained competition in the shield market, where they produced six of the ten high-reliability models available. The takeover marks the beginning of "The Great Shield Wars," as the next five-year period has come to be known in the industry, an obvious parallel to the Four-Years War with the Klingons.

FSL

To entrench itself in the high-power end of the market, Wyandotte released the FSL, a modest upgrade of their FSI technology. The announcement, ill-timed to say the least, reached the trade journals on the eve of the Surelox takeover of Landauer SysTech Ltd., which news totally eclipsed the Wyandotte press release in the public eye. To ship designers, however, the announcement was public confirmation that Wyandotte had improved the reliability of its FSI system considerably, though it would be another ten years before the A reliability of the single- and double-phase-shift systems.

FSM, FSN, FSO

In 1/96, with a one-two punch followed by a roundhouse, Charlottes Shields released upgrades of their existing single- and double-phase-shift systems and the most powerful triary transducer generator. Timed to be released throughout the Federation on the same day, Charlottes' megacredit media blitz proclaimed their undisputed lead in the deflector shield industry. With the FSM, they had the most powerful single phase-shift shield generator, with the FSN, its double phase-shift modification, and with the FSO the most powerful triary system.

The next two years were the climax of the Great Shield War, as Wyandotte and Surelox entered into secret price-fixing pacts geared to erode the Charlottes' market. The resulting price war, backed by the Leeper-Fell corporate fortune, eroded the fortune of H. R. Charlotte, as company sales fell to near-zero credit volume and production lines halted because of the resulting glut of generators that remained in the Charlottes warehouses. It was not until the Federation High Court proved collusion that the price war was broken, but the damage to Charlottes Shields financial structure was all but impossible to reverse. Surelox, which had secretly bought substantial blocks of Wyandotte stock, was forced to divest itself of all its shares, and was required to pay nominal damages to Charlottes Shields. The net effect was to bring economic parity to the three industrial leaders.

FSP

On 1/99, an aging Dr. Randolph Webbe, who had been nearly forgotten in the economic battles for shield supremacy, announced the application of transducer technology to his double phase-shift generator, quadrupling the shielding for any given power when compared to the invention that started the industry. The FSP was announced by Surelox, produced in limited quantities, and immediately captured the market for high-power shields.

Design problems affected reliability, and it was not until 2/15 when the M-6 computer interface proved feasible that the reliability rose to the levels enjoyed by the double phase-shift models without the new binary transducer. Even with this fortuitous mating, the shield power maximum remained at 16, though unsubstantiated rumors have been fueling speculation that even this limit, like the fabled Mach 1 limit in early atmospheric aeronautics, will fall to concerted research efforts.

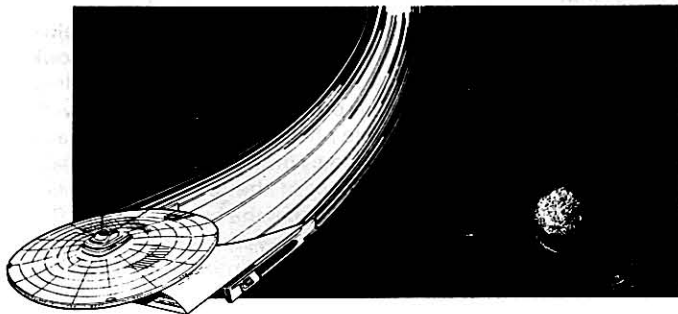

WEAPON SYSTEMS

"The only thing different from our beginnings are the ways and means we use to attack each other."

This quote can be found on the first page of the tactics manual used by the Star Fleet Academy. The author and the date it was written are unknown. Since the beginnings of history, there has been warfare, and so it could have been written at almost any time. The first weapon was probably a stick or a stone, and the javelin and archaic pistol are their successors. The particle beam weapons and the laser weapons of the late twentieth century were the precursors of the laser weapons used 60 years ago, which, in turn, are the precursors of today's phaser weapons. The naval torpedo of the 20th century marks the beginnings of today's photon torpedo.

LASER WEAPONS

FL-1, FL-2

The Williams' Mark 1 was the first laser that was capable of firing at any speed other than a slow crawl, and it was the first laser weapon to be accepted Federation-wide. Developed by Williams Weapons of Omicron Theta II, the demand for this weapon was significant enough to turn the three owners of the company into millionaires overnight. Not only did the design allow the weapon to be fired at a ship speed greater than one-tenth light-speed, but the weapon also had an effective range of four times any previous laser system. The system worked well under normal circumstances, but for some unknown reason it lost power at the most inopportune times.

Just one year later, Williams released the Mark 2 improved system. Though it massed 110 tons more and had no more power, its range was increased 20,000 kilometers. The power loss problem of the Mark 1, caused by a faulty chip in the programming system, was corrected at the same time, and later Mark 1s were built with the problem corrected. The Williams Mark 1 has been given the designation FL-1, and the Mark 2 is now known as the FL-2

FL-3, FL-4

Scientists were stymied with the problem of range for another fourteen years, when Johanson Energy Co-op produced their first production model with a range of 100,000 km in 1/74. In this model, now known as the FL-3, the beam was tightened and held tight by use of a frequency modulator that 'reminded' the beam to stay tight. Use of the modulator also provided a pleasant surprise in that roughly 50% more fire-power was gained at no increase in the power fed into the system.

Johanson used a different computer system, the L-13, to control a power increase on their Mark 1 by 50%, thus making their Mark 2. This meant more fire-power was available in the Mark 2, now known as the FL-4, to be used. The modulator provided the same bonus that it had provided in the FL-3.

FL-5, FL-6

Williams Weapons used the L-14 computer system for fire control on the weapon that is now known as the FL-5, though it took five years of testing before the two systems were made compatible. This increased efficiency and fire-power slightly over earlier models.

Less than a year later, Williams released an improvement, now known as the FL-6. Although no bonus was gained over the previous model, its new power modulator improved the fire-power slightly.

ACCELERATOR CANNON

The accelerator cannon system allowed missiles to be fired at the tremendous speeds required for space warfare. Most missiles used with the system were equipped with nuclear warheads having the destructive power of late-20th-century warheads, which usually was enough to penetrate the hull and shields of any vessel in service at that time.

Loraxial Ltd. was the sole designer of accelerator cannon. Many smaller companies were licensed to manufacture the systems, but Loraxial held all copyrights.

FAC-1

The first accelerator cannon system, now known as the FAC-1, was operational in 1/62. At the time, weapons experts felt that advances in accelerator cannon technology would keep abreast of those in laser technology, but it would be 22 years before any significant advance would become reality, when the L-14 computer was mated successfully to an accelerator cannon system; although the computer had been available for a number of years, the advances in inter-connecting hardware were non-existent until 1 83.

FAC-2, FAC-3

The next year, in 1/84, Loraxial announced production of the system that has become known as the FAC-2. In the interim, cannon design had advanced somewhat. Range and power both were increased by approximately 20%.

Three years later, Loraxial was able to improve the system using the M Series computers. Although range was not increased, use of the M-1 did allow a refined FAC-2 to use a bigger warhead. This new model, now called the FAC-3, was the last cannon to be designed.

PHASER WEAPONS

Before most ship-system research came to a standstill during the Four Years War, scientists involved in laser research had been on the verge of a new discovery. Warren Shillinge of HiBeam Energies Ltd., in experimenting with beams of all types of energy, had discovered a way to "phase energy pulses," as they called the technique. The name phaser naturally was applied to the process, which was vigorously explored at HiBeam Energies, and by the outbreak of the war, success was felt to be so close that research continued unhindered.

Tests of the new weapon were conducted at several research facilities after the original scientists had been divided into four groups. The purpose of this was three-fold. First, many times when several groups are working on the same project, fresh approaches could be taken because different viewpoints were being used. Second, secrecy could be handled more easily by breaking the large group into more easily-watched, smaller groups at isolated facilities. Third and most important with a new weapon of this magnitude, if one research facility were to be destroyed, the others could carry on.

As it turned out, the break-up of the original design team was beneficial, for the groups did branch off in different directions, ending with different uses for the same weapon. All were able to be put into effect in an individual weapon with the proper control system. Early test-models of phaser weapons had heated up the molecules of the target, causing it to burn, but later developments showed that thephasers were capable not only of a heat setting, but also a disintegrate, disrupt, and a stun setting. On disintegrate, the phaser broke down the molecular cohesiveness of the target, causing them to fall apart completely. On disrupt, they would shatter the target by ultrasonic vibrations set into the beam. On stun, a mild setting, they would overload the nervous system of living things, causing them to fall unconscious.

Security proved to be no problem, and fortunately none of the facilities was completely destroyed, though a project head was killed when one test unit exploded.

FH-1, FH-2

Developed in 1/94, the Mark 1 ship-mounted phaser went into full production two weeks after its successful trials, using assembly lines built before the weapon had even been fully tested. As one might have expected, such hurried production allowed quite a few problems to be overlooked. Many of the initialphasers exploded when used on the disrupt setting, but it took a while to evaluate data and realize that ships were blowing up from using their own weapons. The problem was traced to sabotage in the programming of the L-12 computer used for fire control.

The Mark 1, now designated the FH-1 phaser system, was the smallest ship-board phaser to ever be built. It is one of the fewphasers that civilians can purchase and use legally. The technology was miniaturized and refined by Dr. James Wilson, Sr., at Wilson Energies, Ltd., and the first production model of the hand phaser weapon was made in 1/98.

HiBeam introduced the Mark 2, now known as the FH-2, less than a year after the Mark 1 went into production. Range and power were increased slightly, and the modulator used on the old lasers were found to increase damage potential onphasers as well.

FH-3

Nine months later saw the introduction of a new phaser using the M-1 computer. With ranges and hitting power virtually double those of the Mark 2, this much-larger weapon is credited with winning the Four Years War. Many of these weapons were used in action only weeks after rolling off the assembly line, which lay only 6 days travel from the war zone. This weapon, now designated the FH-3, was produced by Mariola Technologies, a short-lived spin-off of Beam Energies now absorbed by that corporation. It, as with all thephasers produced during the war, is still available.

FH-4, FH-5

Basically an upgrade of the same technology as the Mark 1 and Mark 2, Beam Energies' Mark 3 model used the L-14 as the fire control computer. Easier to maintain than the Mark 1 or 2, the Mark 3 gained a reputation for reliability. Because its date of introduction followed that of the FH-3, it is now known as the FH-4.

The Beam Mark 4, now called the FH-5, was still a larger version, giving it extra range and damage capability. It was the last phaser to be put in production during the Four Years War.

FH-6, FH-7, FH-8, FH-9

After the war ended, research still proceeded rapidly at HiBeam Energies, although not quite so desperately as before. The new generation of weapons was designed as a whole, with planned upgrades in range and hitting power. All were to use the M-2 computer, the L series incapable of handling the data processing as fast as was needed.

The first model to see production, the FH-6, is very small for the punch it packs. The FH-7, which HiBeam released the next year, was slightly larger, with range and damage potential increases in proportion to the size increase. The FH-8 and FH-9 followed soon after, completing the range.

The first production models of the FH-9 had problems with control capabilities, but these minor problems were corrected with a modification to the M-2 computer. It was later discovered that modifications could be made to the phaser itself, allowing for the use of unmodified computers.

FH-10

Research to find the solution to the problems of the FH-9 led to the use of the M-4 computer for fire control. Although the link-up was not successful, there were indications that a redesigned phaser might be even more devastating.

Following up on this lead, HiBeam designed the FH-10, which used a significantly different energy modulator than had been used before. The range was not quite as good as

the FH-9, but the damage capabilities were greater and it had only 70% of the mass.

FH-11, FH-12

The greatest range of any phaser to date was attained with the FH-11 in tests on 2/1404.30, but there were problems with beam cohesion, and so the unit was not put into production until nine months later. The FH-11 was nearly 50% larger than the FH-10 and had the capacity to carry the largest punch of any phaser produced up to that time.

Two years later the FH-12 went into production. The third smallest phaser system produced to date, it is considered a good medium phaser, carrying a deadly punch for its size. Warren Shillinge, credited as being the father of the phaser, died the day the FH-12 went into production, and HiBeam Energies has named the FH-12 the 'Shillinge' in his honor.

FH-13

The next year, HiBeam Energies redesigned the FH-11 to use the M-3 computer system for fire control. The project was marginally successful, as the slightly larger phaser that resulted had less power and range than the FH-11 it was based on.

PHOTON SYSTEMS

All missile weapons have the same basic principle: an ejector sends a warhead in a fairly direct line to a target. There have been many types of missile systems throughout history, from the bow-and-arrow and sling-and-rock through the crude pistols and rifles of the 18th through 21st centuries, to today's photon torpedoes. Photon systems can trace their lineage directly back to the torpedoes fired from underwater ships of many cultures, through the warheads fired by the accelerator cannons that the photons replaced.

The accelerator cannons of 1/62 to roughly 2/00 used an accelerator systems to propel a warhead to a target. Large, direct line-of-sight weapons, they were immense machines, massing up to 840 mt. They were impossible to mount on very small craft and range was limited to roughly 100,000 kilometers. What was needed was a small device that could fire a small projectile to a target over 100,000 km away.

Toward the end of the Four Years War, Priscilla Feddic of Loraxial Ltd. had been studying the effects of magnetic fields on antimatter as part of an attempt to develop a smaller, more accurate accelerator cannon. Remembering earlier work at Shuvinaaljis Warp Technologies on a containment system for matter/antimatter mixes, she theorized that these magnetic fields could be made small enough to contain a tiny bit of antimatter. If the container could then be delivered to a target and exploded, she proposed, the antimatter could annihilate whatever it hit.

Unable to convince anyone at Loraxial to seriously study her idea, she worked with Collier Shane in their spare time and finally succeeded in capturing a bit of antimatter in a small magnetic field, which they encased in TriDuralloy. With an antique mortar, they launched their projectile and captured the attention of Loraxial upper management when they destroyed half the parking lot at Loraxial Center XII through a slight miscalculation in trajectories.

From these earthshaking beginnings, the prototype photon missile evolved rather quickly. The launch tube concept was borrowed from submersible craft technology, and the M-2 computer was used to handle programming for the magnetic field generators. The system was operational in six months. It did not require much power to use, and it packed a tremendous wallop, superior to most phaser hits.

FP-1, FP-2, FP-3

The FP-1 system, Loraxial's first operational photon torpedo system, was small, displacing 200 mt. It had an effective range of 120,000 km, and enormous destructive power, but its targeting system was not as well developed as the phaser technology of the time.

Two years later, attempting to create a range of weapons, Loraxial announced the FP-2, a more compact system that could be used on smaller ships. It used the less-sophisticated M-1 computer, but its range and destructive capabilities were not as great as the FP-1. The FP-3, using the L-14 computer, followed, with a greatly reduced range while retaining the punch of the FP-2.

FP-4, FP-5, FP-6

In 2/02, Morris Magtronics, a newcomer to the weapons scene, entered the scene with a bang, announcing the most destructive weapon ever produced. The FP-4 twice the punch of Loraxial's FP-1 to a range of 160,000 kilometers. Simultaneously with the demonstration tests, the company announced its plans to produce a range of weapons, much like HiBeam had when it announced the FH-6.

Soon after, the FP-5 was tested. Slightly smaller than the FP-4 and designed to be used on slightly smaller ships, the test was a failure, and it was eight years until the model saw production. This has been followed by the FP-6, which stepped down the same technology.

FP-7

Loraxial's latest entry into the market has good targeting capabilities but not much punch.

SUPERSTRUCTURE AND SUPPORT SYSTEMS

Because they are so numerous, design and construction details of the superstructure and support systems will not be dealt with in detail, but a general overview of these systems will be given instead. There are many other shipboard systems that are considered standard in construction. These are all generally figured in the price of the hull construction.

HULLS AND LIFE SUPPORT SYSTEMS

Hulls and life support systems are built at one time, usually overseen by one general shipyard. Thousands of companies build these systems, with well over 300 ship air-conditioning manufacturers alone.

Like everything else, hull construction has gradually improved over the years. Research constantly aims at improving the strength of the hull to withstand greater damage. Ships are always built with as many strong interior bulkheads as possible. Often, military vessels have their superstructure strength increased beyond that called for in the design. The cost of this is considered to be well worthwhile.

Hull Designs

Though many people have quipped that you can always tell a Star Fleet vessel because of the shape of the hull, this is not actually true. Most hulls do not follow the familiar saucer-shaped hull originally designed by Chiokis Starship Construction, but its use on most of the prominent military vessels has given this design greater publicity than the thousand upon thousands of designs used in constructing freighters, couriers, and other civilian and small military ships.

There are many standard hull designs available from the major contractors. These standard designs are generally cheaper to build than non-standard ones because of near mass-production capabilities. Construction time is also reduced greatly because all the 'bugs' have theoretically been worked out of the design.

The ship is designed to be compartmentalized in case of emergency. Each compartment can be sealed off and its atmosphere evacuated, the vacuum created smothering any fire instantly. The compartments can also be sealed with its life support intact, isolating trouble areas such as a compartment held by an enemy boarding party.

Air, Water, And Waste Treatment Systems

The air conditioning, waste recovery, water, and, if present, hydroponics systems all are interrelated to conserve the ship's precious store of water. Water use for most personal hygiene is replaced with ultrasonics, and all waste is recycled to reclaim water in it.

Emergency Power Systems

Batteries are carried on most vessels to store power for emergency use. Normally not enough is stored to power weapons or even shields, although there have been reports that a few enterprising engineers have coaxed batteries to do just that in a rare instance. Batteries are normally used for life support systems. Use for anything else will greatly hasten the drainage of them.

Fabricators

Material fabrication units have changed the course of history. They have been considered one of the greatest inventions of all time. Most people today are so used to the idea of fabricators that this is forgotten. With a fabricator of one type or another even in many homes, or in a neighborhood like the corner grocery of long ago, they are taken for granted. Fabricators have eliminated the need to carry an enormous amount of inventory aboard ship.

It is common knowledge that fabricators, including food processors, use patterns stored in computer memory to construct what is needed. What many people do not realize is that each time a fabricator is used a notation is made of what item was made. A royalty is then paid to the company owning the rights to that product's design, formula, or recipe.

NACELLES AND ENGINE MOUNTS

The outward appearance of warp engine nacelles and impulse engine casings would lead one to believe there are only two or three warp engine types, though this is far from being the case. It is the warp engine nacelles and their mounts or the impulse engine casings that are generally similar in design, though the engine housed inside could be vastly different from one ship to the next.

The warp nacelles are standardized for several reasons, the primary being ease of construction and lower construction cost. Second, when a standard design is used the design and construction bugs that plague new equipment designs are eliminated.

Warp engines have always been mounted away from the vessel as far as was practical just in case of trouble. Though this is the practice, less shielding is not used than if the engine were mounted directly on the hull, as many think. The Federation simply feels that heavy shielding coupled with the distance increases the safety factor. All warp engines in the Federation are equipped with ejection systems to fling the warp drives away from the vessel in case of emergency. If a warp engine overloads or becomes unstable, it may be ejected, with the vessel able to move rapidly away under impulse drive.

Some of the control equipment aboard the vessel requires special leaded glass to contain possible radiation leaks. When this equipment must be serviced, heavy radiation suits that completely encase the wearer are essential.

The impulse engines are mounted directly into the hull, and can only be removed by disassembling them. Though they have special shielding to contain radiation, they are considered so safe that they normally are mounted in the main hull of the vessel. Rarely does a crew member even need protective clothing when servicing them.

SHIP CONSTRUCTION FACILITIES

Ship construction facilities vary widely in design and capability. Most today are located off-planet for ease of construction and because very large vessels do not have the atmospheric capabilities that allow them to be built anywhere else. Chiokis Starship Construction has located many of their facilities in asteroid systems, where raw materials are close at hand and very cheap, holding construction costs down. A small energy field is set up around most facilities to protect from wandering debris and unwanted intruders.

Coming upon a ship construction facility in space can be an unusual sight, with half-finished ships and miscellaneous vessel components floating around. Storage in space is free, and room is plenty. Tenders and small work bees take raw material to large fabricators where the sheets of hull material are turned out to exact specifications.

These facilities normally are large skeletal affairs designed to use as small an amount of material themselves as possible while still providing a work platform. They usually have small storage, workrooms, and offices built along the framework wherever they be convenient. Usually the largest of these contains a transporter, as most workers either live planetside, on an asteroid base, or on a ship and commute to work via transporter. These large reception structures also contain mess facilities, medical stations, and offices where problems can be discussed without the need of spacesuits.

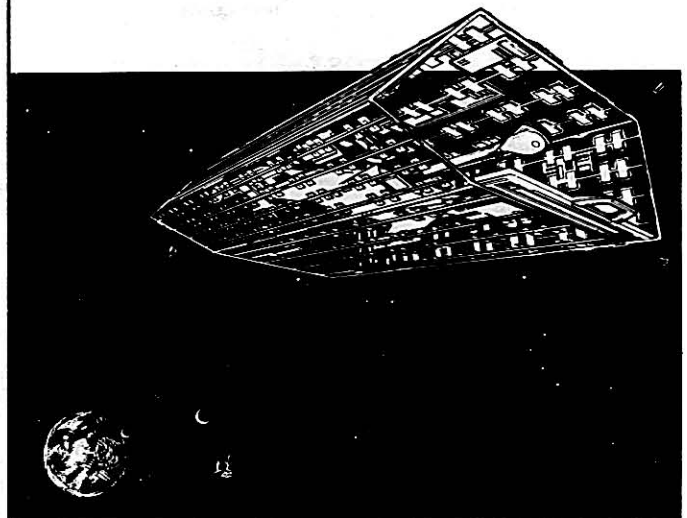

Construction Procedures

Ship construction in a construction/repair facility usually begins with the hull, which is constructed in place using gravitics and force fields to hold it steady within the facility. Many times, a hull is built at one yard and then towed to a nearby engine contractor, where the warp engines are added. If the construction all takes place in one facility, usually the engines are assembled at the manufacturer's plant and then brought to the facility for addition to the hull. Until recently, weapon systems are not added to the vessel until it had passed its initial trials. Lately, however, the practice has been to build the vessel complete with weapon systems before its first tests.

Availability And Cost

When designing and building a starship, cost may play a very important role. To a government, the cost of building a starship is minimal in comparison to that government's total income, and so cost usually is not a factor. This ratio is much higher for a business corporation, however, and it can be staggeringly high for an individual. Thus, when a medium-sized or smaller business or when an individual or group of partners build a starship, the cost of all equipment and for the basic hull must be calculated.

Availability of the various pieces of equipment also may be very important. Starship components are very specialized pieces of equipment, and they generally are not available with ease to anyone but government agencies. Some of the equipment necessary to construct a starship is restricted, either to the seller, to the buyer, or to the user. Quite obviously, buying a warp engine is not as easy as buying a piece of lumber.

CONSTRUCTION COSTS

As budding engineers and designers will note, every piece of a starship costs money. Each table of starship components has a column labeled *COST* (in MCr). The MCr designation is the standard abbreviation for *Megacredits*, or one million Federation Credits. All equipment costs will be given in Federation currency.

CALCULATING TOTAL COST

The total cost of the ship is determined by the cost of all the components required, modified for the mass of the ship. If the design is a new or unique one, a fee for the engineering plans may also be charged.

Estimated Base Cost

When the starship design has been finalized, the designer must total the costs for each component in that design. This is the estimated base cost for the ship. If extensive alterations are required from standard designs, cost overruns may be incurred.

Tonnage Modifier

The base cost of the ship must be increased for the fittings and furnishings that are put in the ship. If the ship is to be sparsely furnished, then the amount necessary for these is much less than if the ship is to be luxurious. The amount necessary to budget for the fittings and furnishings is a function of the ship class and the amount of luxury. Furthermore, as a ship gets larger, there is an increasingly greater chance for inflationary costs to mount up.

Both these factors are reflected in the Tonnage Modifier, which is a function of ship class. The modifier gets larger as the ship displacement gets larger.

Total Cost

Multiply the base cost by the Tonnage Modifier. Add any extra costs, such as design costs and cost overruns. This gives the total cost of the starship.

COMPONENT AVAILABILITY

If the ship is being built by the Federation for Star Fleet use, all components are usually available to contracting ship yards. Certain rare components, however, such as the transwarp engines or Mark VII computer, must be custom-made and are not commercially available. Thus, the *USS Excelsior* carries the Federation's only working transwarp engines. Furthermore, if the ship is being built for use by the private sector, certain restrictions may apply to the commercial sales, purchase, or use of any piece of starship equipment, as detailed below.

The Ship Construction Tables include information on the legality and general black-market availability of starship components. For each component, there is an availability code. This consists of three letters and a two-digit number. The letters give information about any legal restrictions that might apply to the sale, purchase, or use of the component. The number gives information about the availability of the component on the black market and its likely cost there.

LEGALITY CODES

The first letter is the whether or not the owner may sell the item in question. The second letter refers to the legality of purchase. The third tells whether or not the item may be legally used.

For each of these codes, one of three levels may be used. Any time the letter *L* appears, the item is absolutely legal to buy, sell, or use. An *R* means there is some sort of restriction concerning that item. If the item is absolutely illegal to buy, sell, or use, an *I* is used.

Any restricted purchase components may be purchased legally by an accredited starship construction firm. Thus, by definition, unless an individual runs one of these firms, he may not buy any of these components. Likewise, all restricted sale equipment may only be sold by certified suppliers. Good examples of these cases may be seen in other parts of society. By law, the sale or purchase of certain drugs, like stimulants, sedatives, or some narcotics, is restricted to those individuals having the appropriate permits and licenses. If one does not have that permit, he may not buy or sell that item.

Use of the item is slightly different. Certain pieces of equipment may be used by anyone, without any restriction of any kind. A good example of this would be ship's computers; for these, the user need not have any kind of permit to use a computer; he just activates it. Other types of equipment may be used by those with the proper permits. For example, only firms or individuals with a license to operate warp engines may do so legally. Illegal Use items may not be used by anyone except Star Fleet. An example of this would be most ship's weaponry; if individuals are not Star Fleet personnel, they may not legally use Illegal Use weapons under any circumstances.

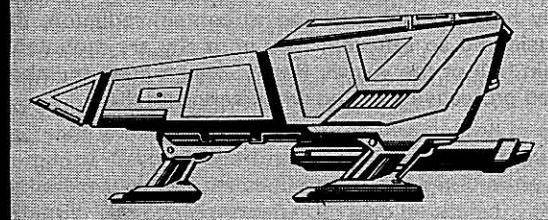
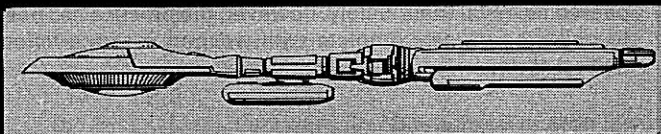

AVAILABILITY CODES

Almost anything may be bought for a price. No matter how legal or illegal an item is, someone, somewhere, has one for sale. Any individual wishing to buy an item within the Federation may do so, but he probably will have to do some searching, and he most certainly will pay much more than the item would cost if purchased legally.

The two-digit Availability Code is an indication, on a scale of 1 to 100, of the difficulty that an individual would have in purchasing an item, either legally on the open market, or illegally on the black market. Obviously, some items will be easier to find than others. Legal Purchase/Legal Use items (like computers) will be very easy to buy, and will have a correspondingly high Availability Code. Restricted components, like warp engines, will not be as easy to find, and

chances are an individual would have to search for a while before he finds such a component. Illegal items, like phasers, are very difficult to find and will have a very low Availability Code.

With some items, there is no Availability Code. This means that the item is simply not commercially available at all. Such items are, like the new transwarp engines, custom-built. This does not mean that an individual could not have the item built, if he had the money. If the item were a Legal Sale/Purchase/Use item, it could even be special-ordered from the company that made the original. For other items, there usually will be a price for which their plans could be stolen and the item reproduced covertly; though this would be an exorbitant amount of money, because industrial espionage is very costly and very dangerous, it is possible.

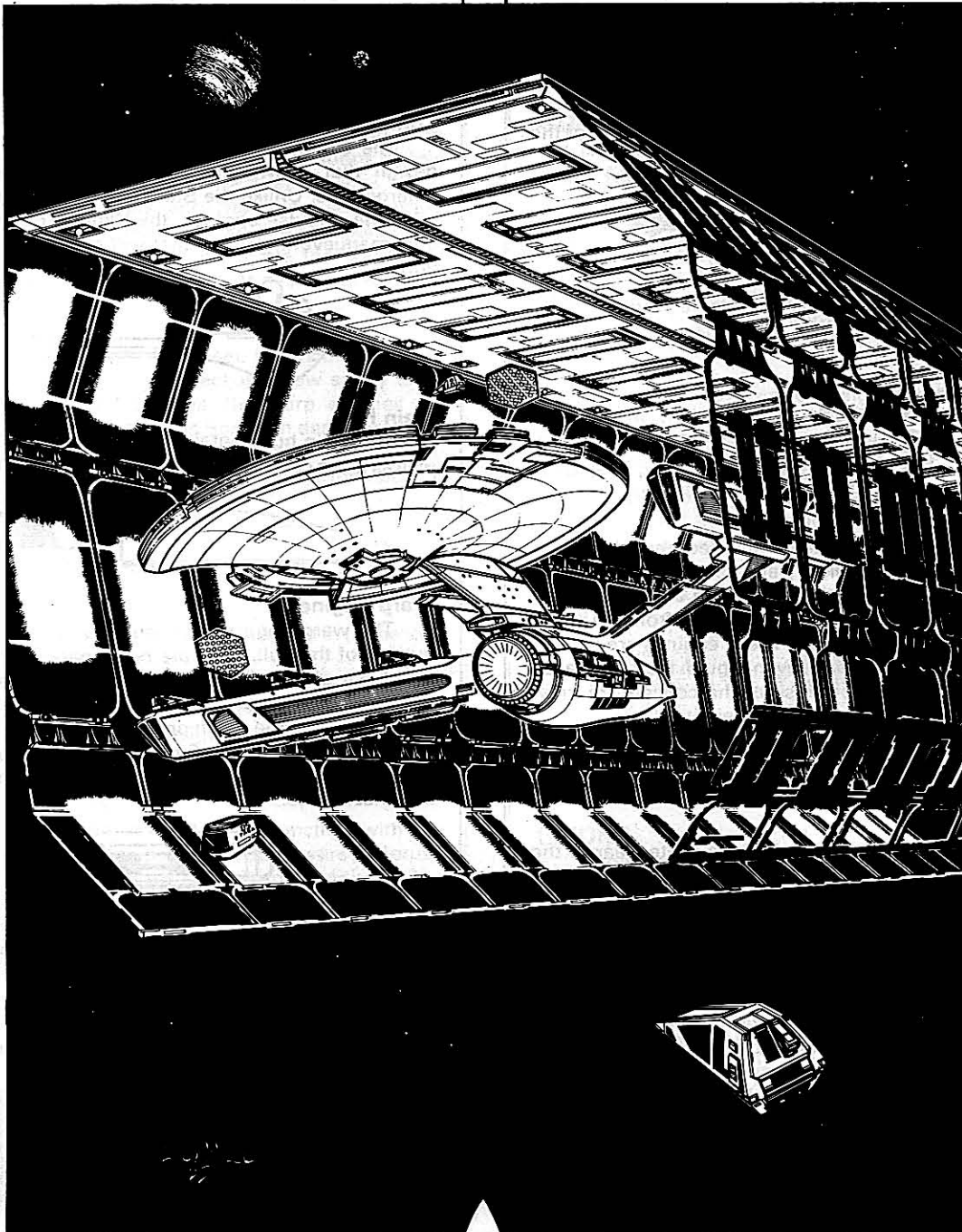

Warship Design Manual

DESIGN PHILOSOPHY



STAR FLEET

Star Fleet ship design has remained consistent for the last 40 years. The saucer-shaped primary hull attached to a secondary hull or engine mount is the most common for all capital ships. Ships built for the private sector will be found in a wide variety of configurations.

Primary Hull

The primary hull contains all of the ships operating stations except for the engineering section. It is capable of being separated from the rest of the ship in case of emergency. In the case of ships that do not have a secondary hull, the engineering section is located in the lower aft portion of the saucer, just under the impulse drive system.

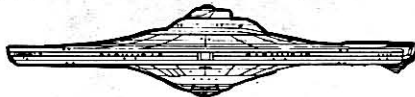

Secondary Hull

The secondary hull contains the engineering functions of most ships. The sensor array, shuttlebay and secondary bridge are also located here.

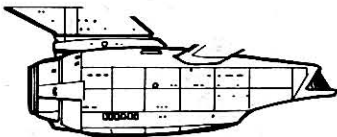

Warp Engines

The warp engines are always mounted away from and usually to the rear of the primary and secondary hulls. This allows the engines to be jettisoned during an uncontrolled matter/anti-matter mix, thus sparing the crew from the catastrophic explosion that will occur. These engines are heavily shielded against radiation leaks, even though they are placed well away from the ship, because of the concern for crew safety; this accounts for the heavier weights.



Impulse Engine

The impulse engine is located at the center rear of the primary hull. It is shielded heavily enough that engineering technicians in this area are not required to wear any protective clothing.

Weapons

The Federation mounts its beam weapons in banks because it allows for more effective firing during combat. The standard configuration is one bank firing forward/port, one firing forward, and one firing forward/starboard. Photon torpedoes are usually mounted in pairs that fire forward.

Only in recent years has it become more common to mount any weapons covering the aft of the ship, whether they be beam weapons or missile weapons. This is due to the tactics of the Klingons and Romulans, whose tactics are to fly past an enemy and fire into usually unprotected aft areas with their aft-firing weaponry.

Defense Shields

Federation vessels use the most effective shields for their type and mission requirement. The general opinion is that it is better to spare the crew from incoming fire than to deliver massive blows with the weapons. Because of this, starship captains pride themselves on their abilities to outmaneuver and out-think their opponents.



KLINGON IMPERIAL NAVY

Klingon ship design has not changed substantially in the last 60 years. Most all vessels separate the command pod from the main hull.

Command Pod

The command pod is mounted on a boom or neck, a design that allows the pod to be jettisoned in case of emergencies. Unlike the Star Fleet primary hull, which contains the impulse engines, the Klingon command pod has only maneuvering retros that will allow it to maintain position.



Main Hull

The main hull contains all the engineering functions as well as troop carrying facilities, shuttlebays, and the engines.

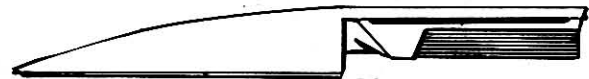

Warp Engines

The warp engines are usually mounted aft and to the outside of the hull. They are not separated from the hull as are those of Star Fleet vessels, nor are they as easily jettisoned. The Klingon nacelles do not have heavy shielding and do not provide much protection from the radiation emitted from the engines. Furthermore, Klingon engineering technicians wear very little protective clothing, making this duty hazardous.



Impulse Engine

The impulse engine is mounted in the center aft of the main hull. Like the warp engines, it does not have much shielding.

Weapons

Disruptors are usually mounted as individual weapons. These fire mainly forward and aft positions, though all arcs of fire are covered.

After the discovery of photon technology, the Klingons began mounting photon torpedoes both fore and aft. Usually the forward torpedo is in the command pod and can be a nasty surprise for an unsuspecting enemy coming to take the prize.

The Klingon use of the Romulan plasma weapon is very limited. This weapon must be used at close range, which is in keeping with Klingon tactics. It is best used with the cloaking device, however, which means using power to remain hidden while closing with the enemy. The Klingon commander would rather use his power to move his ship into his enemy and shoot the entire way.

Defense Shields

The Klingon battle tactics do not lend themselves to using defense shields. Most Klingon vessels have under-powered shield generators because of this philosophy.



ROMULAN IMPERIAL NAVY

Unlike the Klingons and Federation, the Romulans have changed their design style in recent years. The original designs were of a teardrop shape with wings mounting warp engines on the ends. Of course there were variations on this design, but it remained unchanged for over 60 years.

Approximately 15 years ago, Romulan shipbuilders began making ships that looked more like the giant birds they so admire. These designs incorporate the bridge-forward design, and some use a boom or neck to extend the bridge forward.

Warp Engines

The Romulan Navy, like Star Fleet, places the warp engines away from the main hull because crew safety is an important factor. Aside from this, the warp engines are placed wherever they look best, as Romulan designers build their ships for aesthetics as much as for practicality. It is therefore not uncommon to find ships with engines forward.



Impulse Engine

The impulse drive system is always located in the center-aft position. It is heavily shielded.

Weapons

The Romulans have three basic weapon types that they can incorporate into their designs: disruptors, plasma weapons, and photon torpedoes.

Disruptors are usually mounted in banks so that all fields of fire are covered equally.

The plasma weapon is used in conjunction with the cloaking device on capital ships such as destroyers and cruisers; some have been used on escorts and monitors. The weapon is most often mounted forward, but it has been mounted in the aft position on occasion.

The Romulans have recently acquired the photon torpedo. These weapons are becoming more popular and can be found on many new Romulan designs. The torpedo is mounted in both fore and aft positions, though, in some cases, it has been mounted to fire port or starboard.

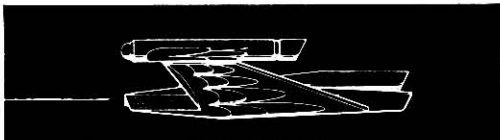

Cloaking Device

Contrary to popular belief, the Romulan cloaking device is not used on all ships. This device is effective but is dangerous to use. The effects of the device on personnel are not fully understood, and it has been responsible for incapacitating crewmembers while in operation. Until recently, the cloak was only used on destroyers and cruisers, but it is now known to be used on escorts, monitors, and scouts. The Romulans are well known for their hit and run tactics and this device and plasma weapon combination has been the demise of many an enemy.

Defense Shields

The Romulan concern for the safety of their crews has led them to develop efficient shields. Romulan ships use the most effective shields for the ship type and mission.



GORN NAVY

Not much is known about Gorn design philosophy.

Warp And Impulse Engines

It appears that the Gorn do not place their warp drives away from the main hull and that they use very little engine shielding. It has been speculated that the Gorn themselves are capable of withstanding large doses of radiation, and this allows them to use less engine shielding. The impulse engine is placed in the center-aft position and also uses little protective shielding.

Weapons

There seems to be no set design for weapons placement. Gorn ships use many weapons both individually and in banks. These are placed all around the ship. The torpedo is also used both in the fore and aft position.

Defense Shields

The Gorn, it seems, are less concerned about defensive shielding than even the Klingons. It will be noted that their shield technology lags far behind that of the other major races. From this, it is easy to understand why the Gorn like to get in close and slug it out.



ORIONS

Orion design philosophy is simple: anything goes. As spacefaring businessmen, the Orions will build to suit.

DESIGN REQUIREMENTS CHECKLIST

The following table contains a list of the most common equipment and sections of a starship. It gives information on the quantity of the various devices and areas, and it gives the amount of space that should be allocated for the equipment or section on a designer's deck plan. The quantity usually is given in relation to the number of crewmen, the displacement of the ship, or some other design consideration. The space required is given in standard squares 1.5 meters on a side or in SCU (1 standard square by 1.3-meter-deck tall).

DESIGN REQUIREMENTS CHECKLIST

Item	Quantity	Space Requirement
Airlock	Minimum of 1	3 squares minimum; size and shape varies widely.
Armory (combat ship only)	1 for Class I – III 2 for Class IV – VII 3 for Class VIII – XI 4 for Class XII – XIII 5 for Class XIV – XV	3 squares minimum
Batteries	In units of 5, as needed	22 squares per unit
Beam Weapon	Variable	
Bridge	1 for Class I – VI 2 for Class VII – XV	1 square per 3000 mt, minimum of 3 squares Minimum of 1 square per manned command, helm, and navigation station Minimum of 2 squares for each other manned control station Minimum of 1 per manned crew station
Briefing Room	Variable	15 to 25 squares
Brig	1 on Class VI ships or larger	Variable; cells usually require 3 squares minimum.
Cabin	1 on combat vessels On passenger vessels, 1 per officer, 1 per passenger group of 1 to 4	18 to 30 squares
Cargo Hold	Minimum of 1	1 square per SCU required
Chapel	Variable	
Chart Room	On combat vessels, 1 On other vessels, variable	5 to 9 squares
Computer	Minimum of 1	1 square per 4000 mt
Decontamination Room	1 on Class VII ships or larger	4 squares
Engineering Control Room	1 on Class I – V 2 on Class VI – XV	1 square per 10,000 mt Bridge controls, 2 to 4 squares
Environmental Suit Locker	1 per every 10 crew	1 or 2 squares per locker
Fire Control Center	1 per weapons system type Auxiliary centers for each system on many warships	3 squares
Food Processor	Minimum of 1 per vessel	1 square per 20 crewmembers; usually larger on larger vessels
Galley	Variable	4 to 12 squares
Gymnasium	1 on Class VII or larger	Variable
Head	Variable	1 square per every 2 crewmembers or passengers
Hydroponics Section	1 on Class VII or larger	Variable
Impulse Engine	1	Variable
Laboratories	Variable	Variable
Laundry	1 on Class VII or larger	Variable; each unit occupies 2 squares
Life Support Controls	Engineering set only on Class I – VII Bridge environmental station on larger ships	Already added to engineering control room size 2 to 4 squares on bridge
Life Support Equipment		15% to 20% of a vessel's space
Lounges	Variable	Variable
Material Fabricators	Variable	Minimum 1 square per every 10 crew
Media Center	Variable	Variable
Messhall	Minimum of 1 per 100 crewmembers	Variable
Missile Weapons	Variable	Variable
Recreation Center	At least 1 on all Class II or larger	1 square per every 5 crew
Sensors	1 set per vessel	Variable
Shield Generator	1	2 to 8 squares
Shuttle Bay	Maximum of 1	Minimum of 20 squares per shuttle Most Class VII or larger have extra bays to accommodate transient shuttles
Sickbay	Minimum of 1 on vessels of over 100 crew	Variable
Stateroom	Variable	Average of 9 squares per crew member
Storage Area	Variable	Variable
Tractor/Pressor Beam	1 per vessel	1 to 8 squares
Transporter	Minimum of 1 personnel transporter per every 50,000 tons Minimum of 1 emergency trans- porter on Class IX or larger	3 squares per pad 1 square per pad
Cargo transporter variable	Variable	
Turbolift	Variable	Variable
Wardroom	Minimum of 1 on vessels with over 6 Officers	Variable
Weapon Mounting Hardpoint	One per weapon	5% larger than weapon

Gamemastering Ship Construction

Before actual ship construction can begin, the various components for the starship must be located, purchased, and transported to the construction site. The plans for the ship must be obtained or commissioned, and the construction site and crew must be contracted.

DESIGNING THE SHIP

The first step in this process is creating or obtaining the plans. The plans should be up to the player characters, who may choose to use the Ship Construction Tables to create the specific statistics for the ship. The **Introduction To Starship Design** and the chapter on **Constructing A Starship** will be of value in this.

If they choose, the players may wish to use the **Design Requirements Checklist** to help create deck plans for their proposed vessel. The **Ship Construction Glossary** will help familiarize them with the various terms used in astronautics.

The cost of the design usually is a percentage of the ship's total cost, and will be covered below, in the section on **Determining Construction Costs**.

LOCATING EQUIPMENT

After the design has been decided upon, the equipment must be located. This section deals with that process. Two factors must be considered here: the legality of the items required and their availability.

LEGALITY

Legality Code

In the Ship Construction Tables, a column is given for Availability of the various pieces of equipment used in starship construction. This column gives listings such as *LRL/23*. The three letters at the front of this listing are the Legality Code that applies in Federation space.

In the Legality Code the first letter indicates the legality of sale in Federation space. The second letter indicates the legality of ownership in Federation space, and the third letter indicates the legality of use in Federation space. The letter *L* means that the sale, ownership, or use is legal. The letter *R* means that the sale, ownership, or use is restricted in some way, as discussed below. The letter *I* means that the sale, ownership, or use is illegal in UFP space.

The Legality Code of any particular item might have a substantial bearing on its availability and on its ultimate cost. This is discussed in the section on **Availability**. If the player characters are not operating in Federation space or will never go there, then the Legality Code probably will not apply to them except as it deals with the availability and cost of the equipment they intend to use in the construction of their starship. If, however, the player characters intend to operate *legally* in Federation space, they will want to be careful to design a ship that allows them to do this, either using only legal equipment or dealing with the proper authorities to allow them to purchase, own, and operate restricted equipment (or even, with the connivance of Star Fleet, illegal equipment).

Restricted Sale, Ownership, And Use

The following table gives some common restrictions that could be important in the sale of equipment with the Legality Code of *R*. Examples have been provided in many cases.

Restrictions On Sale	
Type Of Sale/Restriction	Example
Sale to all individuals	
Proof of eligibility	Alcohol
Record of sale given to controlling authority	Pistol
Sale to certain individuals	
Proof of eligibility	Syringes
Record of sale given to controlling authority	Morphine
Sale to all corporate entities	
Proof of incorporation	
Record of sale given to controlling authority	
Sale to certain corporate entities	
Proof of eligibility	Research matter
Record of sale given to controlling authority	U-238
Sale to government agency	
Proof of eligibility	Firearms
Record of sale given to controlling agency	Plutonium
Restrictions On Use	
Permit necessary for unrestricted use.	
Permit necessary for regulated use.	
Use must be reported to controlling agency.	

AVAILABILITY

Availability Code

In the Ship Construction Tables, the column for Availability gives a listing such as *LRL/23*. The two digits at the end of the listing are the Availability Code.

Basically, the Availability Code is the percent chance that any given piece of equipment is available at the time that the player characters attempt to acquire it. This is assumed to be the base chance, which may be modified by the circumstances surrounding the sale, as discussed below, by the characters' Luck or Intelligence, or by their skill in *Administration, Security Procedures, Trade And Commerce, or Streetwise*.

Modifiers For Attributes And Skills

The higher a character's score in LUC or INT, the easier it will be for that character to find any given piece of equipment. Conversely, those characters with a low LUC or INT score will have more difficulty in the search.

Furthermore, the more skillful the characters are in dealing with bureaucracies, in negotiating trade deals, or in circumventing various security procedures, or in dealing on the street, the easier it will be for them to acquire anything they desire. *Streetwise* characters know *where* to look, traders know *how* to look, and administrators or security personnel know *where not* to look.

Modifiers For Location

Where the characters look is also very important. In Federation space, the legality of an item plays a part, but in other locations it does not. What matters most is which race manufactures the item and how far from the point of manufacture the point of sale is.

Thus, given that the Availability Codes are given for the average purchase (legality aside) in the Federation, items manufactured outside the Federation will be harder to find in the UFP interior than on the border, and even harder to find on the UFP frontier.

Items that are restricted or illegal in the UFP will be easiest to find in the Triangle area, where rumor has it that anything can be bought for a price, on worlds belonging to the Orion Colonies, and on the Klingon border. The accompanying table of Availability Code modifiers shows this. For each manufacturing race and location, three modifiers are given depending on the legality of purchase (not ownership or use); the first is for goods with the Legality Code of *L*, the second is for goods with the Legality Code of *R*, and the third is for goods with the Legality Code of *I*.

AVAILABILITY CODE MODIFIERS

For Attribute Scores

Attribute	Score	Modifier
LUC	80 or more	+10
	60 to 79	+5
	40 to 59	0
	less than 40	-5
INT	80 or more	+10
	60 to 79	+5
	40 to 59	0
	less than 40	-5

For Skill Ratings

Skill	Rating	Modifier
Administration	70 or more	+5
	less than 30	-5
Security Procedures	70 or more	+5
	less than 30	-5
Trade And Commerce	60 or more	+5
	80 or more	+10
Streetwise	60 to 79	+5
	less than 30	-5

For Location Of Search

Location	Manufacturing Race			
	Federation	Klingon	Romulan	Orion
UFP Interior	0/-5/-15	-5/-15/-25	-5/-20/-30	0/-5/-15
UFP Frontier	0/0/-5	-15/-25/-40	-15/-30/-50	0/-10/-25
UFP On Klingon Border	+5/+5/0	+5/+5/0	+5/+5/+5	+10/+5/0
UFP On Romulan Border	+5/+5/0	-5/-10/-15	0/0/0	+10/+5/0
UFP On Gorn Border	0/0/-5	-5/-15/-25	-5/-20/-30	0/-10/-25
Triangle	+10/+5/0	+15/+15/+15	+10/+10/+10	+20/+20/+20
Orion Colonies	+10/+5/0	+10/+10/+10	+5/+5/+5	+20/+20/+20
Klingon Empire	0/0/0	+20/+20/+20	0/0/0	+10/+10/+10
Romulan Star Empire	-10/-10/-10	-5/-5/-5	+10/+10/+10	+5/+5/+5

Availability Rolls

Once all the modifiers have been determined, they are added to or subtracted from the Availability Code. Then, percentile dice are rolled. If the roll is less than or equal to the modified Availability Code, the item is available for purchase, and price negotiation may begin. If the roll is greater than the modified Availability Code, the player characters have not found what they were looking for, and will have to try again.

One Availability Roll may be made per game week per group of player characters. The players should choose the player character who has the best chance of finding the item in question, and use that character's modifiers for the attempt.

For example, assume the purchasing character has a LUC score of 76 and an INT score of 50. He has a Skill Rating in Administration of 29, in Security Procedures of 72, in Streetwise of 59, and none in Trade And Commerce. He is trying to buy FSI deflector shield generators.

From the list of Federation equipment in the Ship Construction Tables, the Legality Code is LRL and the Availability Code is found to be 50. This means that the purchase is legal in Federation Space, the ownership of the shields is restricted by the UFP, but it is legal to operate the shields if one owns the generators. There is a base 50% chance to find the shields.

Because of the character's LUC score, there is a modifier of +5 to this, and because of his INT score there is no modifier. Because of his Skill Rating in Administration, there is a modifier of -5, and because of his Skill Rating in Security Procedures, there is another modifier of +5. His lack of skill in Trade And Commerce gives him no modifier, but his skill in Streetwise gives him a modifier of +5. The total modifier is +10.

The adjusted Availability Code is 60 (50 + 10 = 60). This is the target for the Availability Roll.

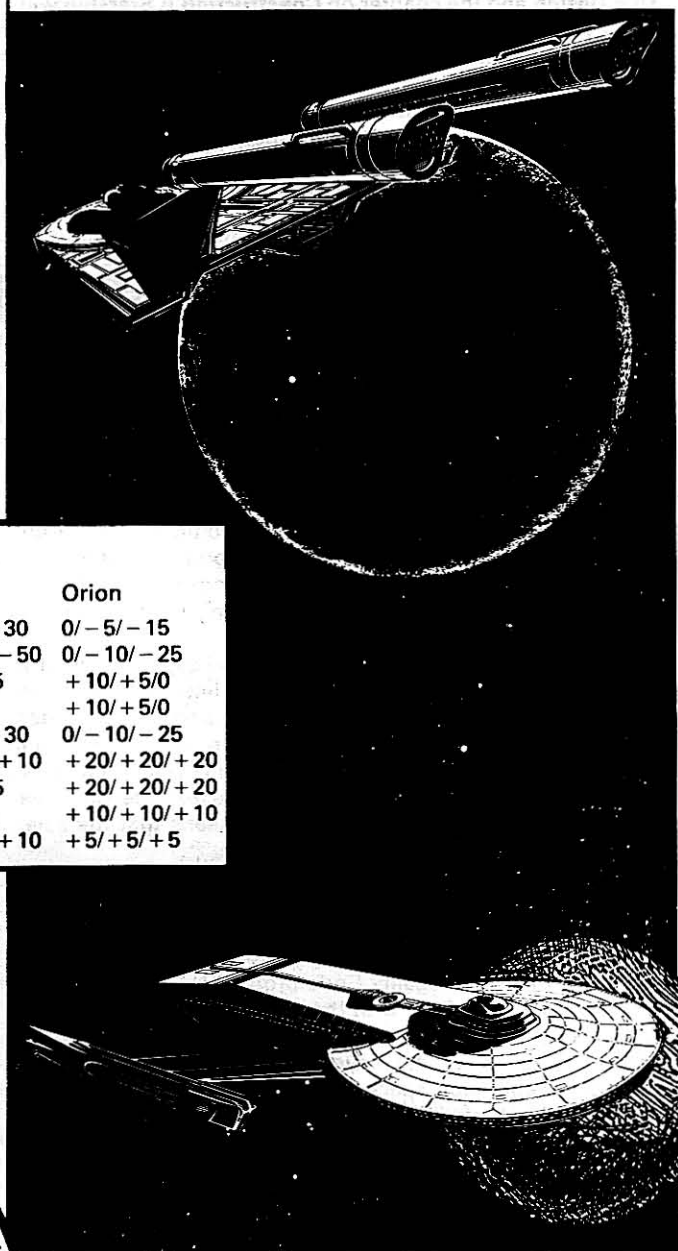

DETERMINING CONSTRUCTION COSTS

The cost of the ship is determined from the cost of the ship design (if it is an unusual one), the total cost for the components, and the cost of actually constructing the ship and installing the components. For true role playing excitement, the players may even haggle with the architect over the design fees, with the suppliers for each of the major pieces of equipment, and with the contractor over the final construction costs and the inevitable cost overruns.

For those characters interested in financing the above activities, the FASA publication **Trader Captains And Merchant Princes** gives many details about dealing with financial institutions.

ESTIMATED BASE COST

The base cost of the ship is determined from the total base cost of the components needed totalled with the cost for the superstructure strength of the vessel and the hull cost.

Estimated Base Component Cost

To estimate the base cost of the components, add up the base costs found in the Cost column of the Ship Construction Tables. Cost should be calculated for the ship's computer, its warp engine(s), its impulse engine, its shield generators, and its weapons (if any). The actual cost may be greater or less, depending on the purchase negotiations.

For example, the Larson component cost is 699MCr. The cost of each component, determined from the Ship Construction Tables, is shown below.

Number	Component	Cost (MCr)
1	M-1 Computer	48
1	FWC-2 Warp Engine	264
1	FIB-1 Impulse Engine	11
1	FSC Shield Generator	4
6	FH-4 Phaser Weapons	336
2	FP-2 Photon Torpedoes	36

Estimated Hull Cost

The estimated cost for the hull of the ship covers the estimated cost for materials needed for constructing the hull, the pylons, the nacelles, and other parts of the superstructure. It is the estimated cost for actual construction, including the cost of labor and facilities. It also must include, the cost of all life-support, electrical, hydraulic, and electronic systems needed to make the components function in the ship.

This cost is dependent, to a large degree, on the size (mass) of the vessel, and on the superstructure strength of the vessel. The table below gives the estimated cost for constructing the hull itself and the cost for each superstructure point the ship will have. This cost may be greater, depending on whether or not there are cost over-runs.

To use the table, find the ship class in the left-hand column. In the center column, cross-reference the cost of the hull itself. In the right-hand column, find the cost of each point of superstructure. Multiply the number of superstructure points by this cost and add it to the hull cost. This will give the total base cost of the hull.

SHIP HULL COSTS

Ship Class	Hull Cost (MCr)	Superstructure Cost (MCr)
I	.5	.5
II	1	.5
III	2	.5
IV	3	.5
V	5	.6
VI	7	.6
VII	9	.6
VIII	11	.7
IX	14	.7
X	17	.7
XI	20	.8
XII	24	.8
XIII	28	.8
XIV	32	.9
XV	36	1.0

For example, the Larson Class VII Destroyer has a Base Hull Cost of 15MCr. The hull cost from the table is 9MCr, and each superstructure point costs .6MCr. It has 10 superstructure points, and so the cost for the superstructure is 6MCr (.6MCr/point x 10 points = 6MCr).

Total Base Cost

Add the Base Component Cost and the Base Hull Cost. This will give the Total Base Cost of the ship.

For example, the Larson Class VII Destroyer has a Base Component Cost of 699MCr and a Base Hull Cost of 15MCr. The Total Base Cost of the ship is 714MCr. Such a ship will most likely be far beyond the reach of any group of player characters.

DESIGN COST

If the design is a unique one, a designer's fee is calculated as a percentage of the theoretical cost of the ship. Once the particulars about the ship class and components (engines, computer, shield generators, weapons, and hull) have been determined, the total base cost of the ship is calculated. The design fee will be equal to 1D10 + 5%, rounded up, of this base cost.

As an example, let us assume that the players have presented a design that, when finished, will total 40MCr. As the ship is not a standard design, the referee rolls one die. If the roll is 4, the designer's fee will be 9% (roll of 4 + 5 = 9%). This adds a designer's fee of 3.6 MCr to the total cost (40MCr x 0.09 = 3.6MCr). This brings the total cost to 43.6MCr.

PURCHASING EQUIPMENT

Once a desired piece of starship equipment has been located, its price must be determined. The Ship Construction Tables have a column that gives the open market price for any piece of equipment. This price must be modified if the equipment is purchased on the black market to reflect the illegality of the purchase. It also should be modified to take into account the attributes and skills of the negotiating player character. These modifiers are discussed in the paragraphs below.

Black Market Price

To determine the final cost of the component in question, simply find the modified Availability Code in the following table, and multiply the base cost of the equipment by the multiplier shown.

BLACK MARKET PRICE MULTIPLIERS	
Adjust. Avail. Code	Multiplier
01 to 10	10
11 to 20	8
21 to 30	6
31 to 40	5
41 to 50	4
51 to 60	3
61 to 70	2
71 to 80	1.5
81 to 90	1.3
91 to 99	1.1

Purchase Negotiations

If the player character has skill in *Trade And Commerce* or *Value Estimation*, they may be used to lower the final price of the item. The character may make a Skill Roll against his or her rating in each of these skills. For each successful roll, he or she may reduce the cost of the component by 1 percent. Thus, if both rolls were successful, the cost of the component will be 2% less than calculated.

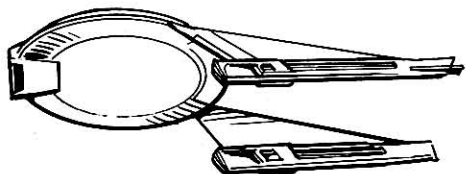

In the example above, our character found his deflector shields within the Triangle area. He now makes his deal with the supplier. The shields would normally cost 3MCr. Checking the table above, we find that an availability of 89 gives us a price multiplier of x2. Thus the shields cost him 6MCr. He has no Trading skill, but does have some skill in Value Estimation (28). He rolls percentile dice against that rating, and succeeds with a roll of 02. 1% of 6MCr is .06MCr, so the final price of those shields is 5.94 MCr.

DO-IT-YOURSELF SHIP CONSTRUCTION

If the characters wish to use a piece of equipment that has an availability code of *None*, or if they are unwilling to wait long enough for a hard-to-find item to surface, or if they are unable to make a necessary or really desirable purchase for some reason, a different set of rules apply. Instead of buying those components outright, someone may buy or steal the plans and the player characters could have the components built.

The cost for finding someone to steal the plans should be quite high, if the task is even possible at all. The exact cost is up to the gamemaster. One possible guideline is to apply a cost multiplier of 3D10 + 40 to the base cost of the component; this will give the amount to pay the thief and the craftsmen.

Even better would be, if the players *really* want that item bad enough, to have *their* characters break in and steal the plans. Not only will you increase the danger to the characters for such an insane action, but will provide an interesting scenario in its own right.

ACTUAL COST

When all the parts of the starship have been assembled, through legal, illegal, or dubious means, the final assembly cost of the ship is determined as above, using the ship's tonnage as a price modifier. As we can see, buying or building a ship with the aid of the black market will allow the characters much more freedom over the end product, but will cost many times more than if the ship were purchased through conventional channels.

Actual Ship Cost

When deriving the cost of building a starship, many cost factors apply. First, total the cost of all pieces of equipment, including weapons, shield generators, engines, and computer. Also calculate the cost of any additional superstructure points above those given by the total size of the vessel. This total is then multiplied by the Tonnage Modifier, selected from the table below.

The Tonnage Modifier takes into account the ship's fittings and furnishings – the things that make it spartan or luxurious, barren or comfortable. It also takes into account the creeping inflation that is inevitable in dealing with the increasing number of items that must be purchased for larger ships.

To use the table, find the ship class in the left-hand column. Then, choose a column to the right depending on the amount of luxury desired. Cross-indexing will give the Tonnage Modifier. Multiply the Estimated Cost of the ship by the Tonnage Modifier to give the Actual Cost.

Tonnage Modifier To Construction Costs				
Class Range	Modifier			
	Spartan	Average	Good-Quality	Luxurious
I – II	1.0005	1.001	1.003	1.005
III	1.001	1.002	1.005	1.01
IV – V	1.002	1.003	1.008	1.02
VI	1.003	1.004	1.01	1.03
VII – VIII	1.004	1.005	1.02	1.04
IX and up	1.005	1.008	1.025	1.05

For example, the players decide to build a 40MCr, Class I vessel, which costs 43.6MCr when the design costs are added in. They have some money to burn, and they decide to live in the lap of luxury. The estimated cost of the vessel (43.6MCr) will be multiplied by the Tonnage Modifier of 1.005 determined from the table. This makes the final cost actually 43.8MCr. Amazing the ways a gamemaster can suck up the player characters' money, isn't it!

Cost Overruns

If the gamemaster so desires, cost overruns may be calculated as well. These may be calculated in any way the gamemaster chooses, but 1D10% of the total cost of the ship is not unreasonable. If this method is chosen, the gamemaster should roll one die to determine the percentage the overrun will cost.

For example, the gamemaster determines that the players will have cost overruns on a ship that would otherwise cost 43.8 MCr. He rolls one die, and gets an 8. This means that the overruns will cost an extra 8%, or 3.5MCr (roll of 8% x total cost of 43.8 MCr = 3.5MCr). Thus, although the ship's estimated price tag was 40MCr, the actual cost to the player characters is 47.3MCr!

Ship Construction Tables

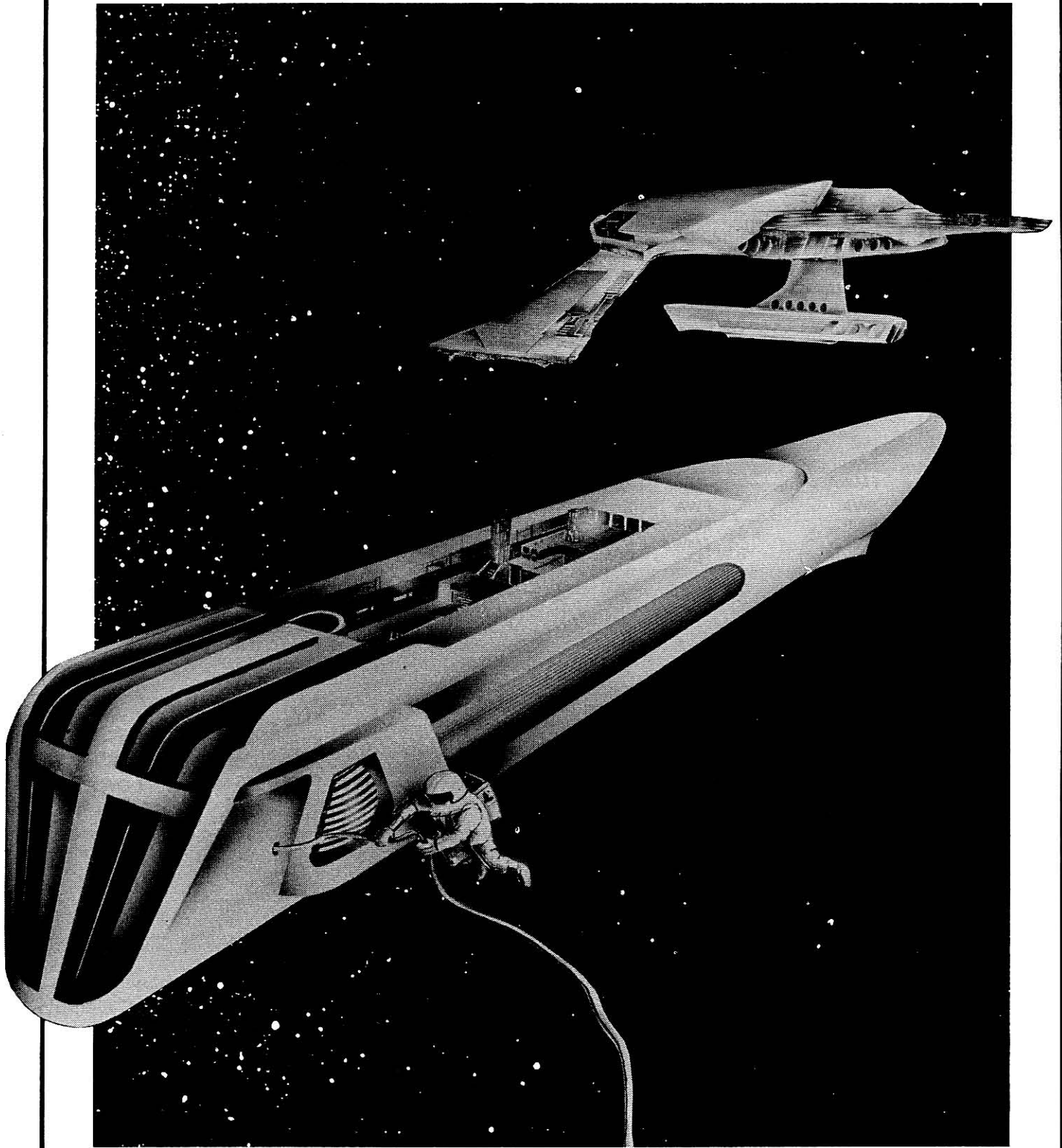



UNITED FEDERATION OF PLANETS



CONTROL COMPUTER SYSTEM TYPES						
Control Computer Type	System Mass (mt)	Appropriate Ship Classes	SS Requirement	Maximum WDF Allowed	Availability	Cost (MCr)
L-12	50	I-III	0.1	2	LLL/90	4
L-13	450	I-IX	0.3	5	LLL/88	11
L-14	1050	II-IX	0.5	10	LLL/85	17
M-1	2900	IV-X	0.9	30	LLL/82	48
M-2	3800	VII-XII	1.1	40	LLL/74	60
M-3	4700	VIII-XIII	1.5	50	LLL/60	71
M-4	5750	IX-XIV	2.0	70	LLL/42	83
M-6	6000	X-XV	2.0	90	LLL/20	150
M-7	11500	XIII	3.0	150	LLL/None	—

CONTROL COMPUTER SUITABILITY						
Control Computer Type	Single Warp Engine Type	Tandem Warp Engine Type	Impulse Engine Type		Deflector Shield Generator Type	Maximum WDF Allowed
L-12	FWA FMWA	None	FIA FIB-1,2 FIC-1,2	FID-1,2 FIE-1 FMIA	FSA FSC	2
L-13	FWA FWE FWH FMWA	FMWA	FIA FIB FIE-1,2 FMIA	FIC FID	FSA FSC FSE FSG	5
L-14	FWA FWB FWC-1 FWD-1 FWE FWH FMWA	FWA FWH FMWA	FIA FIB FIC FMIA	FID FIE-1,2 FIF-1	FSA FSB FSC FSD FSE FSM	10
M-1	All Warp	FWA FWB FWE-1 FWH	FIA FIB FIC	FID FIE FIF	FSA FSB FSC FSD FSE FSM	30
M-2	All Warp	FWA FWB FWD-1 FWE FWH	FIA FIB FIC FID	FIE FIF FIG-1	FSA FSB FSC FSD FSE FSM FSF FSN	40
M-3	All Warp	FWA FWB FWC-1 FWD FWE FWH	FIA FIB FIC FID	FIE FIF FIG-1,2	FSA FSB FSC FSD FSE FSL FSF FSM FSG FSN	50
M-4	All Warp	FWA FWB FWC FWD	FWE FWF FWG-2 FWH	All	All But FSP	70
M-6	All Warp	All Warp	All	All	All	90
M-7	All Warp FTWA	All Warp FTWA	All	All	All	120



WARP ENGINE TYPES

Warp Engine Type	Total Mass (mt)	Power Units Available	Single Engine Use		SS Requirement	Availability	Cost (MCr)
			Control Computer Requirement	Stress Column (Eng/SS)			
FWA-1	2,400	6	L-12	F/G	0.2	RRR/81	2.4
FWA-2	2,400	8	L-12	H/L	0.2	RRR/80	3.0
FWB-1	18,000	9	L-14	L/M	1.4	RRR/77	36
FWB-2	18,000	12	L-14	L/N	1.4	RRR/74	42
FWC-1	60,000	14	L-14	N/L	4.8	RRR/72	240
FWC-2	60,000	20	M-1	M/K	4.8	RRR/68	264
FWD-1	50,000	10	L-14	K/F	4.0	RRR/65	200
FWD-2	50,000	16	M-1	L/F	4.0	RRR/63	227
FWE-1	40,000	8	L-13	F/I	3.2	RRR/57	123
FWE-2	40,000	12	L-13	F/J	3.2	RRR/57	135
FWF-1	62,000	18	M-1	F/K	5.0	RRR/49	248
FWG-1	50,000	20	M-1	C/D	4.0	RRR/38	303.5

Warp Engine Type	Total Mass (mt)	Power Units Available	Tandem Engine Use		SS Requirement	Availability	Cost (MCr)
			Control Computer Requirement	Stress Column (Eng/SS)			
FWA-1	4,800	6 ea	L-14	G/K	0.4	RRR/81	5.3
FWA-2	4,800	8 ea	L-14	J/M	0.4	RRR/80	6.6
FWB-1	36,000	9 ea	M-1	M/O	2.8	RRR/77	79
FWB-2	36,000	14 ea	M-1	M/O	2.8	RRR/74	93
FWC-1	120,000	16 ea	M-3	O/M	9.6	RRR/72	528
FWC-2	120,000	20 ea	M-4	N/M	9.6	RRR/68	581
FWD-1	100,000	12 ea	M-2	L/G	8.0	RRR/65	440
FWD-2	100,000	18 ea	M-3	M/G	8.0	RRR/63	500
FWE-1	80,000	8 ea	M-1	G/K	6.4	RRR/57	270
FWE-2	80,000	13 ea	M-2	G/K	6.4	RRR/57	300
FWF-1	124,000	20 ea	M-4	G/L	10.0	RRR/49	545
FWG-1	100,000	26 ea	M-6	D/F	8.0	RRR/38	668
FWH-1	8,000	10 ea	L-14	O/R	0.6	RRR/84	9
FMWA-1	600	2 ea	L-13	A/A	0.1	RRR/88	1.2
FTWA-1	156,000	38 ea	M-7	D/F	12.4	RRR/None	—

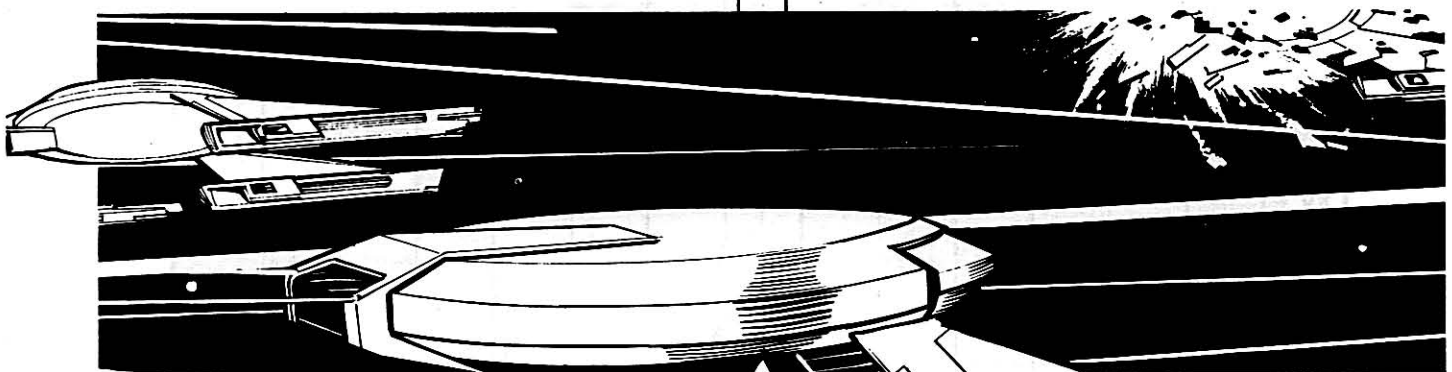



UNITED FEDERATION OF PLANETS



MOVEMENT POINT RATIO TABLE: SINGLE WARP ENGINE

Movement Point Ratios

Ship Class	1/4	1/3	1/2	1/1	2/1	3/1	4/1	5/1	6/1	7/1	8/1	
I	FWA-1 34 8/10	FWA-1 26 7/9	FWA-1 17 7/9 FWA-2 23 7/9	FWA-1 8.5 7/9 FWA-2 11.5 7/9 FMWA 3 2/3	FWH-1 7 5/6 FMWA 1.5 2/2							
II		FWA-1 26 7/9	FWA-1 17 7/9	FWA-1 8.5 7/9 FWA-2 11.5 7/9	FWA-1 4 6/8 FWA-2 6 7/9	FWH-1 7 5/6						
III				FWB-1 13 6/7 FWB-2 17 6/7	FWA-2 6 7/9 FWB-2 8.5 5/6	FWH-1 7 5/6						
IV				FWB-1 13 6/7 FWB-2 17 6/7	FWB-2 8.5 5/6	FWH-1 5 4/5						
V				FWD-1 14 7/9 FWD-2 23 7/9	FWB-1 6.5 5/6 FWB-2 8.5 5/6	FWE-1 6 7/9	FWE-2 4 7/9		FWG-1 6 8/10			
VI					FWC-1 10 8/10 FWC-2 14 7/9 FWD-1 7 7/9	FWD-2 11.5 6/8 FWE-1 6 7/9	FWC-1 7 8/10 FWD-1 5 6/8	FWE-2 6 7/9 FWD-2 7.5 6/8	FWF-1 6.5 6/8		FWG-1 6 8/10	
VII					FWC-2 14 7/9	FWE-1 6 7/9	FWC-1 7 8/10 FWD-1 5 6/8	FWD-2 7.5 6/8 FWE-2 6 7/9	FWC-1 5 7/9 FWF-1 6.5 6/8		FWG-1 6 8/10	
VIII					FWC-2 9.5 6/8		FWC-1 5 7/9 FWD-1 5 6/8	FWD-2 7.5 6/8 FWE-1 4 7/9	FWG-1 6 8/10 FWE-2 4 7/9	FWF-1 6.5 6/8		
IX						FWE-1 4 7/9		FWC-1 5 7/9 FWD-2 6 5/7	FWE-2 4 6/8 FWF-1 6.5 5/7	FWF-1 5 5/7	FWG-1 5 7/9	FTWA 8.5 13/15
X								FWE-2 4 6/8		FWF-1 5 5/7	FWG-1 5 7/9	FTWA 8.5 13/15
XI								FWE-2 4 6/8		FWG-2 5 4/6		
XII										FWG-2 5 4/6		
XIII										FWG-2 5 4/6		
XIV											FWG-2 4 4/6	
XV											FWG-2 4 4/6	
XVI											FWG-2 4 4/6	
XVII												FWG-2 3.5 3/5
XVIII												FWG-2 3.5 3/5



UNITED FEDERATION OF PLANETS



MOVEMENT POINT RATIO TABLE: TANDEM WARP ENGINES								
Movement Point Ratios								
Ship Class	1/1	3/2	2/1	3/1	4/1	5/1	6/1	7/1
I	FMWA 6 2/3		FMWA 3 2/2					
II	FWA-1 17 7/9 FWA-2 23 7/9	FWA-1 11.5 7/9	FWA-1 8.5 6/8	FWA-1 6 6/8 FWH-1 9 5/6				
III			FWA-2 11.5 6/8	FWH-1 9 5/6	FWA-1 4 5/7			
IV			FWA-2 11.5 6/8 FWB-2 20 8/9	FWH-1 9 5/6	FWH-1 7 4/5			
V			FWB-1 13 7/8	FWB-1 8.5 6/7	FWB-2 13 7/8	FWH-1 7 4/5		
VI				FWB-1 8.5 6/7		FWH-1 7 4/5	FWB-2 10 6/7	
VII				FWE-1 7.5 7/9	FWE-2 12 7/9			
VIII			FWD-2 26 6/8	FWE-2 12 7/9 FWE-1 7.5 7/9	FWD-1 17 7/9			
IX			FWC-1 23 8/10 FWD-2 26 6/8	FWC-2 19 7/9 FWD-1 11.5 7/9	FWE-1 7.5 7/9 FWE-2 12 7/9	FWE-1 6 6/8 FWE-2 9 6/8	FWF-1 14 6/8	
X				FWC-1 15 7/9 FWD-2 17 5/7		FWC-2 9 6/8 FWD-1 8.5 6/8 FWE-1 6 6/8	FWE-2 9 6/8 FWF-1 14 6/8 FWG-1 18.5 8/10	FTWA 18 12/14
XI				FWC-1 15 7/9 FWD-2 17 5/7		FWC-1 11.5 6/8 FWD-2 13 4/6 FWE-2 9 6/8	FWF-1 14 6/8 FWG-1 18.5 8/10	FTWA 18 12/14
XII					FWD-2 13 4/6 FWE-2 9 6/8	FWF-1 14 6/8 FWG-1 18.5 8/10	FWF-1 11.5 5/7 FWG-1 15 7/9	FTWA 18 12/14
XIII					FWD-2 13 4/6	FWF-1 11.5 5/7	FWG-1 15 7/9	FTWA 18 12/14
XIV						FWF-1 11.5 5/7	FWG-1 15 7/9	FTWA 18 12/14
XV							FWG-1 12 6/8	FTWA 18 12/14



IMPULSE ENGINE TYPES							
Engine Type	Total Mass (mt)	Power Units Available	Control Computer Required	Ship Classes Powered	SS Requirement	Availability	Cost (Mcr)
FIA-1	150	1	L-12	I	.1	RRR/88	1
FIA-2	150	2	L-12	I-II	.1	RRR/86	1
FIA-3	150	3	L-12	I-III	.1	RRR/83	2
FIB-1	200	2	L-12	VII	.1	RRR/83	1
FIB-2	200	4	L-12	IV-VIII	.1	RRR/82	2
FIB-3	200	6	L-13	V-IX	.1	RRR/80	3
FIC-1	255	1	L-12	III-VI	.1	RRR/76	1
FIC-2	255	3	L-12	V-IX	.1	RRR/74	2
FIC-3	255	6	L-13	VII-XI	.1	RRR/70	3
FID-1	315	2	L-12	IV-VII	.1	RRR/70	2
FID-2	315	4	L-12	VII-XII	.1	RRR/65	3
FID-3	315	8	L-13	XII-XX	.1	RRR/63	4
FIE-1	350	4	L-12	VI-VIII	.1	RRR/64	3
FIE-2	350	8	L-13	VII-XII	.1	RRR/60	4
FIE-3	350	16	M-1	XI-XX	.1	RRR/57	5
FIE-1	438	12	L-14	VIII-XI	.1	RRR/55	4
FIF-2	438	16	M-1	IX-XIII	.1	RRR/50	5
FIF-3	438	20	M-1	XI-XX	.1	RRR/46	7
FIG-1	1060	24	M-2	X-XIII	.1	RRR/47	10
FIG-2	1060	32	M-3	XII-XV	.1	RRR/40	18
FIG-3	1060	40	M-4	XIV-XV	.1	RRR/32	34
FMIA	10	1	L-12	I	.1	RRR/92	1

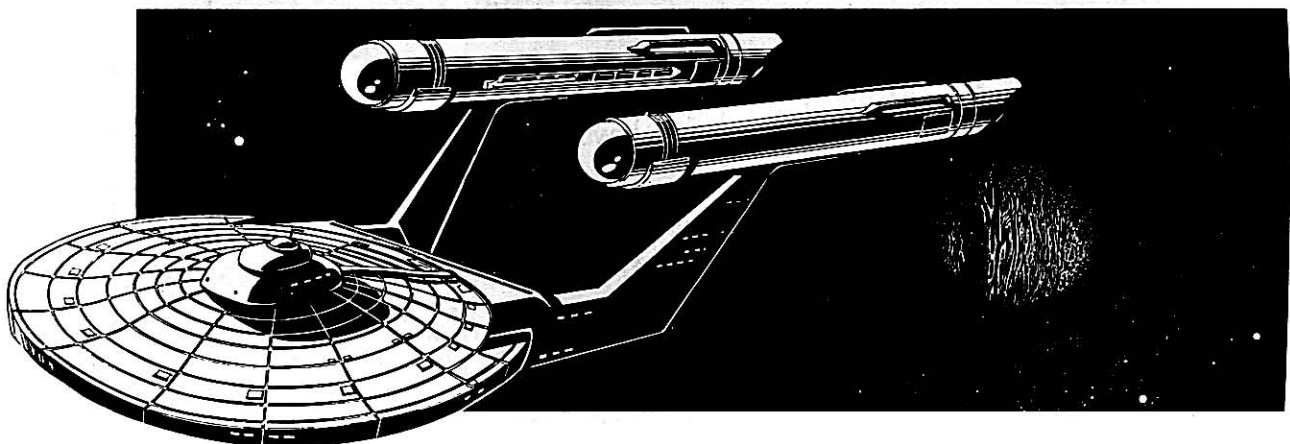

MOVEMENT POINT RATIO TABLE: IMPULSE ENGINES



Ship Class	Movement Point Ratios														
	1/4	1/3	1/2	1/1	3/2	2/1	3/1	4/1	5/1	6/1	7/1	8/1			
I	FIA-1 6	FIA-1 4	FIA-1 3 FIA-2 6	FIA-1 1.5 FIA-2 3 FIA-3 4	FIA-1 1 FIA-2 2	FIA-3 2									
II			FIA-2 6	FIA-2 3 FIA-3 4	FIA-2 2	FIA-3 2									
III				FIA-3 4 FIC-1 1.5	FIA-3 2 FIB-2 3	FC-1 1	FIB-1 1 FIB-2 2	FIB-3 3	FIB-1 1 FIB-2 1.5	FIB-3 2 FIC-1 1					
IV				FIC-1 1.5	FIB-2 3 FIC-1 1	FID-1 1.5 FIB-2 2	FIB-1 1 FIB-2 1.5	FIB-3 3 FIC-1 1	FIB-1 1 FIB-2 1.5	FID-1 2	FIB-3 1				
V				FIC-1 1.5	FIB-2 3 FIB-3 4 FIC-1 1	FC-2 2 FD-1 1.5 FC-2 1.5	FIB-2 2 FIB-3 3 FIB-3 2	FID-1 1	FIB-1 1 FIB-2 1.5	FIC-1 1 FIC-2 1	FC-2 1 FID-1 1				
VI				FIC-1 1.5	FIB-2 3 FIC-1 1 FIC-2 2	FID-1 1.5 FIE-1 3	FIB-2 2 FIB-3 3 FIB-3 1.5	FID-1 1 FIE-1 2	FIB-2 1.5 FIB-3 2 FIC-2 1	FID-1 1 FIE-1 1.5	FC-2 1 FID-1 1 FIE-1 1				
VII				FIB-2 6	FIB-1 1.5 FIB-2 3 FIB-3 4 FIC-2 2	FC-3 4 FD-1 1.5 FIE-1 3	FIB-2 2 FIC-2 1.5 FIC-3 3 FIE-1 2		FIB-2 1.5 FIC-2 1 FIC-3 2 FID-1 1	FIE-1 1.5	FC-2 1 FIC-3 2 FID-1 1 FIE-1 1	FIE-2 2	FIE-2 2		
VIII					FIB-2 3 FIB-3 4 FIC-2 2 FIC-3 4	FIE-1 1.5 FIE-2 1.5 FIF-1 3 FIC-3 8.5	FIB-3 2 FIC-2 4 FIC-3 3 FD-1 1	FIE-1 2 FIE-2 4 FIF-1 6 FIF-2 7.5	FIB-3 2 FIC-2 1 FIC-3 2 FID-2 1.5	FIE-1 1.5 FIE-2 3 FIF-1 4	FC-2 1 FIC-3 2 FID-2 1 FIE-1 1	FIE-2 2 FIF-1 3.5	FID-2 1 FIE-2 2 FIF-1 3		
IX					FC-2 2 FC-3 4 FIE-2 6 FIF-1 8.5	FIB-3 3 FIC-2 1.5 FIC-3 3 FID-2 2	FIE-2 4 FIF-1 6 FIF-2 7.5	FIB-3 2 FIC-2 1 FIC-3 2 FID-2 1.5	FIE-2 3 FIF-1 4 FIF-2 6	FC-2 1 FIC-3 2 FID-2 1 FIE-2 2	FIF-1 3.5 FIF-2 4.5	FID-2 1 FIE-2 2 FIF-1 3 FIF-2 4			
X					FC-3 4 FIE-2 6 FIF-1 8.5	FIG-1 17	FC-3 3 FID-2 2 FIE-2 4	FIF-1 6 FIF-2 7.5 FIG-1 13.5	FC-3 2 FID-2 1.5 FIE-2 3	FIF-1 4 FIF-2 6 FIG-1 8.5	FC-3 2 FID-2 2 FIE-2 2	FIF-1 3.5 FIF-2 4.5 FIG-1 7	FID-2 1 FIE-2 7.5 FIF-1 3	FIF-2 4 FIG-1 6	
XI					FC-3 4 FIE-2 6 FIF-1 8.5 FIG-1 17		FC-3 3 FID-2 2 FIE-2 4 FIE-3 7.5	FIF-1 6 FIF-2 7.5 FIG-1 13.5	FC-3 2 FID-2 1.5 FIE-2 3 FIE-3 6	FIF-1 4 FIF-2 6 FIF-3 7 FIG-1 8.5	FC-3 2 FID-2 1 FIE-2 2 FIF-3 4.5	FIF-1 3.5 FIF-2 4.5 FIF-3 6 FIG-1 7	FID-2 1 FIE-2 2 FIF-3 4 FIF-3 3 FIF-1 3	FIF-2 4 FIG-1 6	
XII					FIE-2 6 FIG-1 17		FID-2 2 FID-3 4 FIE-2 4 FIE-3 7.5	FIF-2 7.5 FIF-3 13.5 FIG-2 15	FID-2 1 FID-3 3 FIE-2 3 FIE-3 6	FIF-2 6 FIF-3 7 FIF-3 8.5 FIG-2 13.5	FID-2 1 FID-3 2 FIE-2 2 FIE-3 4.5	FIF-2 4.5 FIF-3 2 FIF-3 7 FIG-1 4 FIG-2 9	FID-3 2 FIE-2 2 FIF-3 4 FIF-3 4 FIF-1 3	FIF-2 4 FIG-1 6 FIG-2 7.5	
XIII					FIG-1 17		FID-3 4 FIE-3 7.5 FIF-2 7.5	FIG-1 13.5 FIG-2 15	FID-3 3 FIE-3 6 FIF-2 6 FIF-3 7	FIG-1 7 FIF-2 8.5 FIF-3 4.5 FIG-2 13.5	FID-3 2 FIE-3 4.5 FIF-2 7 FIF-3 6	FIF-3 6 FIF-3 7 FIF-2 9 FIF-3 13.5	FID-3 2 FIE-3 4 FIF-2 4 FIF-3 7.5	FIG-1 6 FIG-2 7.5	
XIV							FID-3 4 FIE-3 7.5 FIG-2 15		FID-3 3 FIE-3 6 FIF-2 6 FIF-3 7	FIG-2 3 FIF-2 13.5	FID-3 2 FIE-3 4.5 FIF-2 9 FIF-3 13.5	FIG-2 9 FIF-2 9 FIF-3 13.5	FID-3 2 FIE-3 4 FIF-2 4 FIF-3 7.5	FIG-3 9.5	
XV							FID-3 4 FIE-3 7.5	FIG-2 15	FID-3 3 FIE-3 6	FIF-3 7 FIF-2 13.5	FID-3 2 FIE-3 4.5	FIF-3 6 FIG-2 9	FID-3 2 FIE-3 4 FIF-3 5	FIG-2 7.5 FIG-3 9.5	
XVI													FID-3 2 FID-3 2 FID-3 2 FIE-3 3	FIE-3 3 FIF-3 4 FIF-3 4	
XVIII															
XIX-XX														FID-3 1 FIE-3 3	FIF-3 3.5



SHIELD GENERATOR TYPES

Shield Generator Type	Total Mass (mt)	Control Computer Requirement	Shield Efficiency Rating	SS Requirement	Availability	Cost (Mcr)
FSA	110	L-12	1	.2	LRL/92	3
FSB	140	L-14	2	.9	LRL/72	6
FSC	160	L-12	1	.2	LRL/90	4
FSD	175	L-14	2	1.0	LRL/71	8
FSE	230	L-13	1	.5	LRL/86	5
FSF	235	M-1	2	1.8	LRL/69	10
FSG	265	L-13	1	.6	LRL/84	6
FSH	305	M-1	2	1.9	LRL/64	12
FSI	510	M-3	3	1.0	LRL/50	18
FSJ	300	L-14	1	1.1	LRL/79	7
FSK	380	M-2	2	2.8	LRL/62	14
FSL	575	M-3	3	1.8	LRL/48	21
FSM	330	L-14	1	1.0	LRL/77	8
FSN	415	M-2	2	2.9	LRL/60	16
FSO	615	M-4	3	3.1	LRL/46	24
FSP	845	M-6	4	2.1	LRL/43	32

MAXIMUM SHIELD POWER
Shield Types/Shield Point Ratios

Ship Class	1/1						1/2						1/3			1/4
	FSA	FSC	FSE	FSG	FSJ	FSM	FSB	FSD	FSF	FSH	FSK	FSN	FSI	FSL	FSO	FSP
I	12	14	14	15	16	16	14	15	15	16	16	16	16	16	16	16
	17	20	20	21	23	23	10	10.5	10.5	11.5	11.5	11.5	7.5	7.5	7.5	5.5
II	11	12	13	14	15	16	11	12	14	16	16	16	16	16	16	16
	16	17	19	20	21	23	8	8.5	10	11.5	11.5	11.5	7.5	7.5	7.5	5.5
III	10	11	12	13	14	16	9	10	14	15	16	16	16	16	16	16
	14	16	17	19	20	23	6.5	7	10	10.5	11.5	11.5	7.5	7.5	7.5	5.5
IV	9	10	11	12	14	16	8	9	13	15	16	16	16	16	16	16
	13	14	16	17	20	23	5.5	6.5	9.5	10.5	11.5	11.5	7.5	7.5	7.5	5.5
V	8	9	11	12	13	15	6	8	12	14	16	16	16	16	16	16
	11	13	16	17	19	21	4.5	5.5	8.5	10	11.5	11.5	7.5	7.5	7.5	5.5
VI	7	9	10	11	13	14	6	7	10	13	16	16	15	16	16	16
	10	13	14	16	19	20	4.5	5	7	9.5	11.5	11.5	7	7.5	7.5	5.5
VII	6	8	9	10	12	13	5	7	10	13	16	16	14	16	16	16
	9	11	13	14	17	19	3.5	5	7	9.5	11.5	11.5	7	7.5	7.5	5.5
VIII	5	7	9	10	11	12	5	6	9	12	16	16	13	16	16	16
	7	10	13	14	16	17	3.5	4.5	6.5	8.5	11.5	11.5	6.5	7.5	7.5	5.5
IX	3	6	8	10	11	12	4	6	8	12	15	16	12	15	16	16
	5	9	11	14	16	17	3	4.5	5.5	8.5	10.5	11.5	5.5	7	7.5	5.5
X	1	5	8	9	10	11	4	5	8	11	14	16	11	14	16	16
	1	7	11	13	14	16	3	3.5	5.5	8	10	11.5	5	7	7.5	5.5
XI	—	4	7	9	10	11	3	5	7	10	14	16	11	14	16	16
	—	6	10	13	14	16	2.5	3.5	5	7	10	11.5	5	7	7.5	5.5
XII	—	3	6	8	9	10	2	4	6	9	13	16	10	13	15	16
	—	5	9	11	13	14	1.5	3	4.5	6.5	9.5	11.5	4.5	6.5	7	5.5
XIII	—	1	5	7	8	9	1	3	4	8	12	15	10	12	14	16
	—	1	7	10	11	13	.5	2.5	3	5.5	8.5	10.5	4.5	5.5	7	5.5
XIV	—	—	3	5	6	8	—	1	2	6	11	14	9	11	12	15
	—	—	5	7	9	11	—	.5	1.5	4.5	8	10	4	5	6.5	5
XV	—	—	1	2	3	5	—	—	—	3	7	12	6	7	8	14
	—	—	1	3	5	7	—	—	—	2.5	5	8.5	3	3.5	4.5	5



UNITED FEDERATION OF PLANETS



PHASER BEAM WEAPON TYPES

Phaser Weapon Type	Total Mass (mt)	Maximum Beam Power	Damage Modifiers			Maximum Range (hex)	Firing Chart	Weapon Damage Factor	SS Requirement (single/bank)	Avail.	Cost (Mcr)
			+3	+2	+1						
FH-1	250	2	-	-	-	8	F	.5	.5/.8	RRR/82	38
FH-2	375	3	-	-	(1-10)	10	H	1.3	.6/.9	RRR/78	56
FH-3	625	5	(1-10)	(11-17)	(18-20)	20	W	5.8	.8/1.2	RRR/47	94
FH-4	375	3	-	(1-8)	(9-14)	14	Q	2.6	.7/1.1	RRR/63	56
FH-5	500	4	-	(1-8)	(9-16)	16	R	3.1	.8/1.2	RRR/60	75
FH-6	300	3	-	(1-7)	(8-13)	13	N	2.3	1.2/1.8	RRR/65	45
FH-7	400	4	-	(1-8)	(9-14)	14	Q	3.2	1.4/2.1	RRR/59	60
FH-8	500	5	-	(1-10)	(11-18)	18	T	4.3	1.6/2.4	RRR/52	75
FH-9	600	6	-	(1-12)	(13-22)	22	X	6.0	1.7/2.5	RRR/50	90
FH-10	420	7	(1-10)	(11-17)	(18-20)	20	W	9.7	2.0/3.0	RRR/45	63
FH-11	600	10	(1-10)	(11-17)	(18-24)	24	Y	10.7	2.2/3.2	RRR/38	90
FH-12	360	6	-	(1-9)	(10-16)	16	R	4.9	1.0/1.5	RRR/58	58
FH-13	620	8	(1-5)	(6-12)	(13-18)	18	T	6.5	1.8/2.7	RRR/50	65

LASER BEAM WEAPON TYPES

Laser Weapon Type	Total Mass (mt)	Maximum Beam Power	Damage Modifiers		Maximum Range (hex)	Firing Chart	Weapon Damage Factor	SS Requirement	Availability	Cost (Mcr)
			+2	+1						
FL-1	500	2	-	-	6	D	.4	.8	LLL/98	9
FL-2	610	2	-	-	8	F	.6	.9	LLL/98	12
FL-3	680	2	-	(1-4)	10	G	.7	1.2	LLL/96	14
FL-4	740	3	-	(1-4)	10	G	1.0	1.5	LLL/94	20
FL-5	820	2	(1-4)	(5-7)	10	H	1.1	2.0	LLL/92	22
FL-6	930	3	(1-4)	(5-7)	10	H	1.4	2.4	LLL/90	32

MISSILE WEAPON TYPES

Missile Weapon Type	Total Mass (mt)	Power To Arm	Damage	Maximum Range (hex)	Firing Chart	Weapon Damage Factor	SS Requirement	Availability	Cost (Mcr)
FP-2	120	1	6	10	H	2.0	.9	RRR/75	18
FP-3	100	1	6	6	D	1.2	.8	RRR/78	15
FP-4	240	1	20	16	S	12.5	2.0	RRR/32	36
FP-5	200	1	16	16	R	9.5	1.8	RRR/45	30
FP-6	160	1	12	14	O	6.7	1.8	RRR/57	24
FP-7	210	1	8	16	R	4.8	.8	RRR/60	32

ACCELERATOR CANNON TYPES

Accel. Cannon Type	Total Mass (mt)	Power To Arm	Damage	Maximum Range (hex)	Firing Chart	Weapon Damage Factor	SS Requirement	Availability	Cost (Mcr)
FAC-2	660	4	10	10	G	1.4	2.4	RRR/46	14
FAC-3	840	4	12	10	H	2.0	2.9	RRR/40	16



CONTROL COMPUTER SYSTEM TYPES

Control Computer Type	System Mass (mt)	Appropriate Ship Classes	SS Requirement	Maximum WDF Allowed	Availability	Cost (Mcr)
ZD-1	90	I - II	0.1	2	LLL/58	6
ZD-2	605	I - VII	0.4	7	LLL/52	21
ZD-3	1,900	III - VII	0.8	16	LLL/44	32
ZD-4	3,850	III - XII	1.2	25	LLL/37	94
ZD-5	7,100	VI - XIV	2.0	40	LLL/25	140
ZD-6	9,800	VII - XV	2.3	60	LLL/16	260
ZD-7	11,550	IX - XX	2.8	80	LLL/12	435
ZD-8	14,680	XI - XX	3.4	140	LLL/03	630

CONTROL COMPUTER SUITABILITY

Control Computer Type	Single Warp Engine Type	Tandem Warp Engine Type	Impulse Engine Type	Deflector Shield Generator Type	Maximum WDF Allowed		
ZD-1	KWA-1	None	KIA KIB KIC-1	KIC-2 KID-2 KIE-1	KSA KSB	2	
ZD-2	KWA KWB KWD-2 KWE-1	KWA-1	KIA KIB KIC	KID KIE-1 KIE-2	KSA KSB KSC KSE	7	
ZD-3	KWA KWB KWC-1 KWC-2	KWA-1 KWB-1 KWF	All But KIF-2	KWD KWE-1 KWE-2	KSA KSE KSI KSM	16	
ZD-4	All But KWG	KWA KWB KWD-2 KWE-1	All	KSA KSB KSC KSD KSE	KSF KSI KSJ KSM	25	
ZD-5	All	KWA KWB KWC-1 KWD	KWE-1 KWE-2 KWF	All	KSA KSB KSC KSD KSE KSF	KSG KSI KSJ KSM KSN	40
ZD-6	All	All But KWG-1	All	All But KSL, KSP	60		
ZD-7	All	All	All	All	80		
ZD-8	All	All	All	All	140		



CLOAKING DEVICE TYPES

Cloaking Device Type	Appropriate Ship Classes	Power To Energize	Control Computer Requirement	SS Requirement	Availability	Cost (MCr)
KCA	II - III	12	ZD-2	None	III/09	10,000
KCB	IV - V	22	ZD-3	None	III/07	15,000
KCC	VI - IX	32	ZD-5	None	III/03	30,000
KCD	X - XI	48	ZD-6	None	III/01	50,000

WARP ENGINE TYPES

Warp Engine Type	Total Mass (mt)	Power Units Available	Single Engine Use		SS Requirement	Availability	Cost (MCr)
			Control Computer Requirement	Stress Column (Eng/SS)			
KWA-1	1,800	5	ZD-1	O/P	0.1	RR1/51	24
KWA-2	2,500	10	ZD-2	P/Q	0.2	RR1/48	37
KWB-1	6,000	8	ZD-2	M/O	0.5	RR1/45	60
KWB-2	7,000	12	ZD-2	O/P	0.6	RR1/40	77
KWB-3	10,000	13	ZD-2	P/P	1.1	RR1/36	105
KWC-1	25,000	14	ZD-3	K/N	2.0	RR1/39	500
KWC-2	25,000	18	ZD-3	L/N	2.0	RR1/35	535
KWC-3	25,000	22	ZD-4	L/M	2.0	RR1/29	650
KWD-1	30,000	16	ZD-3	K/M	2.4	RR1/33	1,200
KWD-2	30,000	10	ZD-2	L/M	2.4	RR1/26	1,150
KWE-1	40,000	9	ZD-2	H/L	3.2	RR1/33	1,650
KWE-2	45,000	16	ZD-3	I/M	3.2	RR1/25	2,375
KWE-3	45,000	20	ZD-4	J/M	3.2	III/18	2,900
KWF-1	35,000	15	ZD-3	H/I	2.8	RR1/21	2,150
KWG-1	65,000	26	ZD-5	I/L	4.1	III/16	3,700

Warp Engine Type	Total Mass (mt)	Power Units Available	Tandem Engine Use		SS Requirement	Availability	Cost (MCr)
			Control Computer Requirement	Stress Column (Eng/SS)			
KWA-1	3,600	5 ea	ZD-2	O/P	0.2	RR1/51	52
KWA-2	5,000	10 ea	ZD-4	O/R	0.4	RR1/48	81
KWB-1	12,000	9 ea	ZD-3	O/Q	1.0	RR1/45	132
KWB-2	14,000	12 ea	ZD-4	P/Q	1.2	RR1/40	170
KWB-3	20,000	13 ea	ZD-4	O/Q	2.2	RR1/36	220
KWC-1	50,000	14 ea	ZD-5	L/O	4.0	RR1/39	1,150
KWC-2	50,000	18 ea	ZD-6	L/O	4.0	RR1/35	1,200
KWC-3	50,000	23 ea	ZD-6	L/O	4.0	RR1/29	1,350
KWD-1	60,000	18 ea	ZD-5	L/N	4.8	RR1/33	2,640
KWD-2	60,000	12 ea	ZD-4	L/N	4.8	RR1/26	2,530
KWE-1	80,000	11 ea	ZD-4	I/L	6.4	RR1/33	3,630
KWE-2	90,000	18 ea	ZD-5	J/M	6.4	RR1/25	5,225
KWE-3	90,000	20 ea	ZD-6	J/M	6.4	III/18	6,380
KWF-1	70,000	16 ea	ZD-5	H/J	5.6	RR1/21	4,730
KWG-1	130,000	28 ea	ZD-7	I/M	8.2	III/16	8,140



MOVEMENT POINT RATIO TABLE: SINGLE WARP ENGINE

Movement Point Ratios



Ship Class	1/3	1/2	1/1	2/1	3/1	4/1	5/1	6/1	7/1
I	KWA-1 21.5 6/7	KWA-1 14 6/7 KWA-2 28.5 6/7	KWA-1 7 5/6 KWA-2 14 6/7						
II			KWA-1 7 5/6 KWA-2 14 6/7 KWB-1 11.5 6/7 KWB-2 17 6/7 KWB-3 18.5 7/8						
III				KWB-1 5.5 5/6 KWB-2 8.5 5/6	KWB-3 9 6/7	KWB-1 4 5/6			
IV				KWB-2 8.5 5/6 KWB-3 9 6/7	KWC-1 10 7/8 KWC-2 13 7/8	KWC-1 6.5 6/7	KWD-1 6 5/7		
V				KWC-3 15.5 7/8	KWB-3 6 5/6 KWC-1 6.5 6/7 KWC-2 8.5 6/7	KWC-3 10 6/7 KWE-3 9 7/8 KWF-1 7 8/9	KWD-1 6 5/7 KWE-1 3.5 5/7		
VI				KWC-1 6.5 6/7 KWC-2 8.5 6/7 KWC-3 10 6/7	KWE-3 10 7/8 KWF-1 7 8/9	KWE-2 5.5 6/7	KWD-1 4.5 4/6 KWD-2 3 5/7 KWE-1 3 5/6		
VII						KWC-1 5 6/7 KWC-2 6.5 5/6 KWC-3 8 5/6	KWE-2 5.5 6/7 KWE-3 7 6/7 KWF-1 5 7/8	KWD-2 3 5/7 KWE-1 3 5/6 KWE-2 4.5 5/6	KWD-2 2 5/6 KWE-1 2 4/6
VIII						KWE-3 7 6/7 KWF-1 5 7/8	KWG-1 9 7/8	KWE-2 4.5 5/6	KWD-2 2 5/6 KWE-1 2 4/6
IX						KWE-3 7 6/7	KWG-1 9 7/8	KWE-2 4.5 5/6	KWE-1 2 4/6 KWE-2 4 5/6
X							KWE-3 5.5 5/6	KWG-1 7.5 6/7	KWE-1 2 4/6 KWE-2 4 5/6
XI								KWE-1 2 4/6 KWE-2 4 5/6	FWG-1 6 5/6 KWE-1 1.5 4/5
XII								KWE-2 4 5/6	KWG-1 6 4/5 KWE-1 1.5 4/5
XIII									KWE-1 1.5 4/5 KWE-1 1.5 4/5
XIV									KWE-1 1.5 4/5 KWE-1 1.5 4/5
XV									KWE-1 1.5 4/5 KWE-1 1.5 4/5
XVI									KWE-1 1.5 4/5 KWE-1 1.5 4/5
XVII									KWE-1 1.5 4/5 KWE-1 1.5 4/5
XVIII									KWE-1 1.5 4/5 KWE-1 1.5 4/5



MOVEMENT POINT RATIO TABLE: TANDEM WARP ENGINES

Movement Point Ratios



Ship Class	1/2	1/1	2/1	3/1	4/1	5/1	6/1	7/1	
II	KWA-1 28.5 7/8	KWA-1 14 7/8 KWA-2 28.5 7/8	KWA-1 7 6/7 KWA-2 14 7/8 KWB-1 13 6/7	KWA-2 9 6/7					
III		KWB-1 25.5 7/8	KWA-1 7 6/7 KWA-2 14 7/8 KWB-1 13 6/7	KWA-2 9 6/7					
IV			KWB-1 13 6/7 KWB-2 17 8/9 KWB-3 9 6/7	KWB-1 13 5/6 KWB-2 11.5 7/8					
V				KWB-1 8.5 5/6 KWB-2 11.5 7/8	KWB-3 6 5/6	KWB-1 6 4/5			
VI				KWB-2 11.5 7/8 KWB-3 6 5/6	KWC-1 13 7/8	KWB-2 8.5 6/7 KWB-3 9 6/7			
VII				KWC-1 13 7/8 KWC-2 17 8/9	KWC-3 21.5 8/9	KWB-2 8.5 6/7 KWB-3 13 6/7 KWC-1 10 7/8 KWD-1 13 6/7			
VIII				KWC-2 17 8/9 KWC-3 21.5 8/9 KWE-1 10 6/8 KWE-3 19 8/9	KWF-1 15 8/9	KWB-2 8.5 6/7 KWB-3 9 6/7 KWC-1 10 7/5 KWC-3 13 7/8 KWE-2 13 7/8	KWD-1 13 6/8 KWD-2 8.5 6/7		
IX				KWC-2 17 8/9 KWE-3 19 8/9 KWF-1 15 8/9		KWC-2 13 7/8 KWC-3 16 7/8 KWD-1 13 6/8 KWD-2 8.5 5/7	KWE-1 7.5 5/6 KWE-2 10 6/7 KWE-3 10 6/7	KWB-3 7.5 5/6 KWE-2 10 6/7	
X				KWE-3 19 8/9		KWC-2 13 7/8 KWD-1 13 6/8 KWD-2 8.5 5/7	KWE-1 7.5 6/7 KWC-3 13 6/7 KWD-1 10 5/7	KWC-2 10 6/7 KWE-1 6 5/7 KWB-3 6 4/5 KWE-2 8.5 6/7	
XI						KWC-2 13 7/8 KWE-3 14 7/8 KWF-1 11.5 7/8	KWC-2 10 6/7 KWC-3 13 6/7 KWD-1 10 5/7	KWD-2 6.5 5/7 KWE-1 6 5/7 KWE-2 8.5 6/7	
XII						KWE-3 14 7/8 KWE-3 11.5 6/7	KWD-1 10 5/7 KWE-1 6 5/7	KWF-1 9 6/7 KWG-1 19.5 6/8	KWD-2 5.5 4/6 KWF-1 7.5 5/6 KWE-2 7 5/6
XIII						KWE-3 14 7/8 KWF-1 11.5 7/8	KWD-1 10 5/7 KWE-1 6 5/7	KWD-2 5.5 4/6 KWF-1 7.5 5/6 KWE-2 7 5/6	KWD-2 5 4/5
XIV						KWF-1 11.5 7/8	KWD-1 10 5/7 KWE-1 6 5/7	KWD-2 5.5 4/6 KWF-1 7.5 5/6	KWF-1 7.5 5/6 KWE-2 7 5/6
XV						KWF-1 11.5 7/8	KWD-1 10 5/7 KWE-1 6 5/7	KWD-2 5.5 4/6 KWF-1 7.5 5/6	KWF-1 7.5 5/6 KWE-2 7 5/6
XVI						KWF-1 11.5 7/8	KWD-1 10 5/7 KWE-1 6 5/7	KWD-2 5.5 4/6 KWF-1 7.5 5/6	KWF-1 7.5 5/6 KWE-2 7 5/6
XVII						KWF-1 11.5 7/8	KWD-1 10 5/7 KWE-1 6 5/7	KWD-2 5.5 4/6 KWF-1 7.5 5/6	KWF-1 7.5 5/6 KWE-2 7 5/6
XVIII						KWF-1 11.5 7/8	KWD-1 10 5/7 KWE-1 6 5/7	KWD-2 5.5 4/6 KWF-1 7.5 5/6	KWF-1 7.5 5/6 KWE-2 7 5/6



IMPULSE ENGINE TYPES

Engine Type	Total Mass (mt)	Power Units Available	Control Computer Requirement	Ship Classes Powered	SS Requirement	Availability	Cost (MCr)
KIA-1	213	1	ZD-1	I	0.1	RRI/48	17
KIA-2	213	2	ZD-1	II	0.1	RRI/42	28
KIA-3	213	3	ZD-1	II-III	0.1	RRI/39	40
KIB-1	325	3	ZD-1	II-V	0.1	RRI/43	34
KIB-2	325	2	ZD-1	V-X	0.1	RRI/40	38
KIC-1	568	2	ZD-1	II-V	0.1	RRI/37	41
KIC-2	568	4	ZD-1	V-X	0.1	RRI/35	50
KIC-3	568	5	ZD-2	IX-XII	0.1	RRI/32	68
KIC-4	568	8	ZD-2	X-XVIII	0.1	RRI/28	97
KID-1	715	6	ZD-2	V-VII	0.1	RRI/31	79
KID-2	715	4	ZD-1	VIII-XII	0.1	RRI/27	62
KIE-1	850	6	ZD-1	X-XIII	0.1	RRI/24	94
KIE-2	850	12	ZD-2	VIII-X	0.1	RRI/18	135
KIE-3	850	18	ZD-3	VI-VIII	0.1	RRI/12	181
KIF-1	960	17	ZD-3	XII-XVIII	0.1	RRI/18	174
KIF-2	960	23	ZD-4	VIII-XII	0.1	RRI/07	278

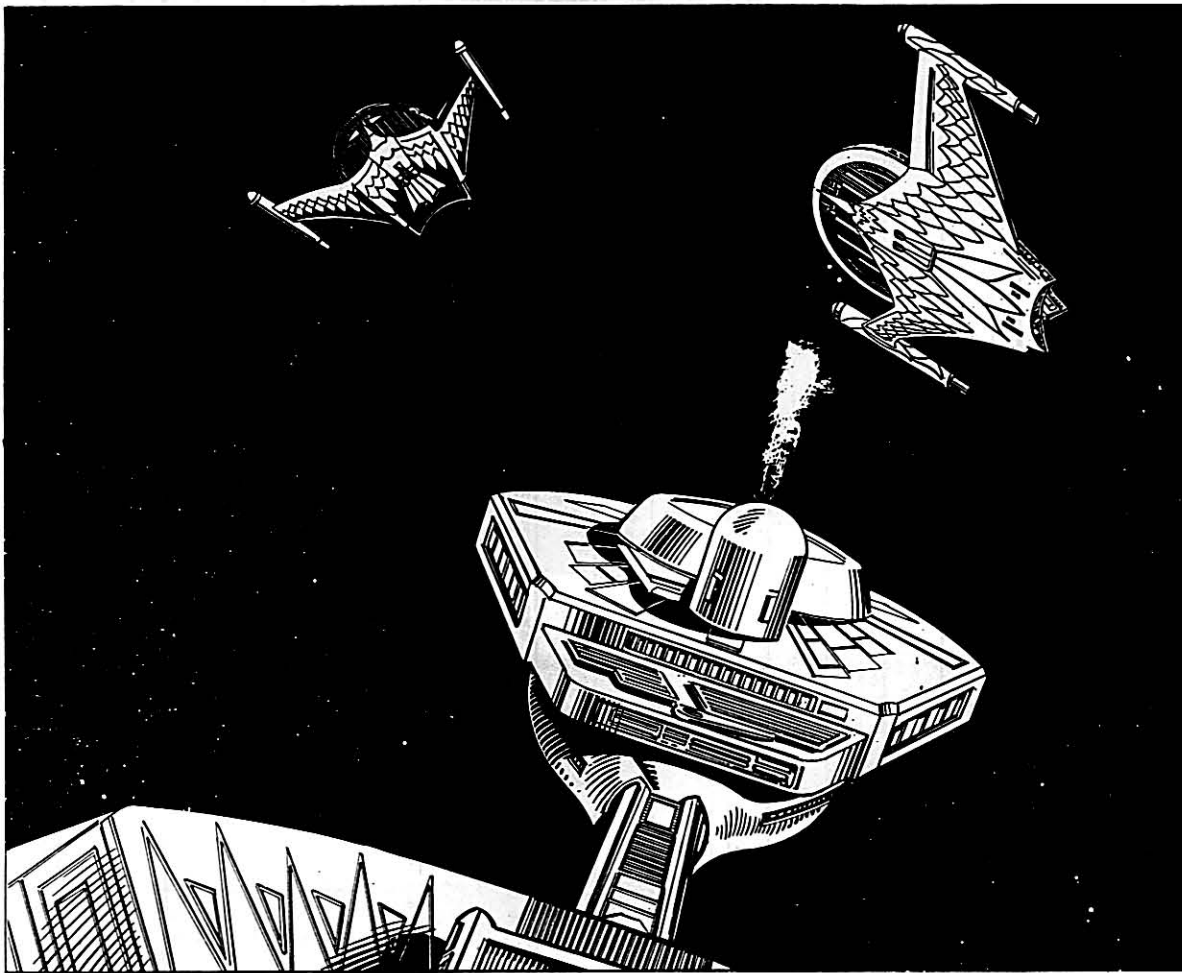

MOVEMENT POINT RATIO TABLE: IMPULSE ENGINE



Movement Point Ratios

Ship Class	1/3	1/2	1/1	2/1	3/1	4/1	5/1	6/1	7/1				
I	KIA-1 4	KIA-1 3	KIA-1 1.5										
II		KIA-2 5.5	KIA-2 3 KIA-3 4 KIB-1 4 KIC-1 3	KIA-2 1.5 KIA-3 2 KIC-1 1.5	KIA-3 1.5 KIC-1 1								
III			KIB-1 4 KIC-1 3	KIB-1 2 KIC-1 1.5	KIA-3 1.5 KIC-1 1								
IV				KIB-1 2 KIC-1 1.5	KIB-1 1.5 KIC-1 1	KIB-1 1 KIC-1 0.5							
V				KIB-1 2	KIB-1 1.5 KIB-2 1 KIC-1 1	KIC-2 2 KID-1 3	KIB-1 1 KIB-2 0.5 KIC-1 0.5	KID-1 2					
VI					KIB-2 1 KIC-2 2	KID-1 3 KIE-3 9	KIB-2 0.5 KIC-2 1.5	KID-1 2 KIE-3 6.5	KIB-2 0.5 KIC-2 1	KID-1 1.5 KIE-3 5			
VII					KIB-2 1 KIC-2 2	KID-1 3 KIE-3 9	KIB-2 0.5 KIC-2 1.5	KID-1 2 KIE-3 6.5	KIB-2 0.5 KIC-2 1	KID-1 1.5 KIE-3 5	KIC-2 1 KID-1 1.5	KIE-3 4	
VIII					KIB-2 1 KIC-2 2 KID-2 2	KIE-2 5.5 KIF-2 11	KIB-2 0.5 KIC-2 1.5 KID-2 1.5	KIE-2 4 KIF-2 8	KIB-2 0.5 KIC-2 1 KID-2 1	KIE-3 5 KIF-2 6.5	KIC-2 1		
IX					KIB-2 1 KIC-2 2 KIC-3 2.5	KID-2 2 KIE-2 5.5 KIF-2 11	KIB-2 0.5 KIC-2 1.5 KIC-3 2	KID-2 1.5 KIE-2 4 KIF-2 8	KIB-2 0.5 KIC-2 1 KIC-3 1.5	KID-2 1 KIE-2 3.5 KIF-2 6.5	KIC-2 1 KIC-3 1 KID-2 1	KIE-2 3 KIF-2 5.5	
X					KIC-3 2.5 KID-2 2 KIE-1 3	KIE-2 5.5 KIF-2 11	KIC-3 2 KID-2 1.5 KIE-1 2	KIE-2 4 KIF-2 8	KIB-2 0.5 KIC-3 1.5 KID-2 1	KIE-1 1.5 KIE-2 3.5 KIF-2 6.5	KIC-2 1 KIC-3 1 KID-2 1	KIE-2 3 KIF-2 5.5	KIF-2 4.5
XI						KIC-3 2 KID-2 1.5	KIE-1 2 KIF-2 8	KIC-3 1.5 KID-2 1	KIE-1 1.5 KIF-2 6.5	KIC-3 1 KID-2 1	KIE-1 1.5 KIF-2 5.5	KIE-1 1 KIF-2 4.5	
XII						KIC-3 2 KIC-4 3 KID-2 1.5	KIE-1 2 KIF-1 1 KIF-2 6	KIC-3 1.5 KIC-4 2 KID-2 1	KIE-1 1.5 KIF-1 5 KIF-2 6.5	KIC-3 1 KIC-4 2 KID-2 1	KIE-1 1.5 KIF-1 4 KIF-2 5.5	KIC-4 1.5 KIE-1 1	KIF-2 4.5
XIII								KIC-4 2 KIF-1 5		KIC-4 2 KIF-1 4		KIC-4 1.5 KIE-1 1	KIF-1 3.5
XIV								KIC-4 2	KIF-1 5	KIC-4 2	KIF-1 4	KIC-4 1.5	KIF-1 3.5
XV										KIC-4 2	KIF-1 4	KIC-4 1.5	KIF-1 3.5
XVI												KIC-4 1.5	KIF-1 3.5



KLINGON EMPIRE



SHIELD GENERATOR TYPES

Shield Generator Type	Total Mass (mt)	Control Computer Requirement	Shield Efficiency Rating	SS Requirement	Availability	Cost (MCr)
KSA	115	ZD-1	1	0.1	LRL/48	5
KSB	160	ZD-1	1	0.2	LRL/45	7
KSC	190	ZD-2	1	0.3	LRL/43	8
KSD	240	ZD-4	2	1.0	LRL/37	16
KSE	230	ZD-2	1	0.5	LRL/27	10
KSF	300	ZD-4	3/2	0.7	LRL/18	15
KSG	310	ZD-5	2	1.4	LRL/36	20
KSH	375	ZD-6	3	2.1	LRL/26	30
KSI	275	ZD-3	1	0.6	LRL/17	12
KSJ	360	ZD-4	3/2	0.8	LRL/42	18
KSK	375	ZD-6	2	2.0	LRL/35	24
KSL	450	ZD-7	3	2.1	LRL/25	36
KSM	345	ZD-3	1	0.9	LRL/16	15
KSN	450	ZD-5	3/2	1.1	LRL/33	23
KSO	470	ZD-6	2	2.1	LRL/23	30
KSP	560	ZD-7	3	2.2	LRL/14	45

MAXIMUM SHIELD POWER Shield Types/Shield Point Ratios

Ship Class	1/1						2/3			1/2				1/3		
	KSA	KSB	KSC	KSE	KSI	KSM	KSF	KSJ	KSN	KSD	KSG	KSK	KSO	KSH	KSL	KSP
I	10 14.5	10 14.5	12 17	12 17	15 21.5	15 21.5	14 13.5	15 14.5	15 14.5	14 10	15 10.5	15 10.5	15 10.5	15 7	15 7	15 7
II	9 13	10 14.5	11 15.5	12 17	15 21.5	15 21.5	13 12.5	15 14.5	15 14.5	13 9.5	15 10.5	15 10.5	15 10.5	15 7	15 7	15 7
III	7 10	8 11.5	11 15.5	11 15.5	14 20	15 21.5	13 12.5	15 14.5	15 14.5	12 8.5	14 10	15 10.5	15 10.5	15 7	15 7	15 7
IV	5 7	8 11.5	11 15.5	11 15.5	14 20	15 21.5	12 11.5	14 13.5	15 14.5	11 8	13 9.5	15 10.5	15 10.5	14 6.5	15 7	15 7
V	5 7	7 10	10 14.5	11 15.5	13 18.5	14 20	11 10.5	14 13.5	15 14.5	11 8	12 8.5	14 10	15 10.5	14 6.5	15 7	15 7
VI	5 7	7 10	9 13	10 14.5	13 18.5	14 20	10 9.5	13 12.5	15 14.5	10 7	11 8	13 9.5	15 10.5	13 6	15 7	15 7
VII	4 5.5	6 8.5	9 13	10 14.5	12 17	14 20	10 9.5	13 12.5	15 14.5	10 7	10 7	13 9.5	15 10.5	13 6	15 7	15 7
VIII	3 4.5	5 7	8 11.5	9 13	11 15.5	13 18.5	9 8.5	12 11.5	14 13.5	8 5.5	9 6.5	12 8.5	15 10.5	12 5.5	14 6.5	15 7
IX	2 3	4 5.5	7 10	8 11.5	10 14.5	12 17	9 8.5	11 10.5	14 13.5	8 5.5	9 6.5	12 8.5	15 10.5	11 5	14 6.5	15 7
X	1 1.5	4 5.5	7 10	7 10	9 13	11 15.5	8 7.5	10 9.5	13 12.5	6 4.5	8 5.5	11 8	15 10.5	11 5	14 6.5	15 7
XI	—	3 4.5	6 8.5	7 10	8 11.5	10 14.5	7 6.5	9 8.5	11 10.5	5 3.5	7 5	10 7	14 10	11 5	13 6	15 7
XII	—	1 1.5	4 5.5	6 8.5	7 10	9 13	5 5	9 8.5	10 9.5	5 3.5	7 5	10 7	14 10	10 5	13 6	15 7
XIII	—	—	1 1.5	4 5.5	5 7	7 10	3 3	8 7.5	9 8.5	4 3	6 4.5	9 6.5	13 9.5	9 4.5	12 5.5	15 7
XIV	—	—	—	2 3	5 7	7 10	1 1	8 7.5	8 7.5	3 2	5 3.5	8 5.5	12 8.5	9 4.5	12 5.5	15 7
XV	—	—	—	1 1.5	3 4.5	5 7	—	7 6.5	8 7.5	1 0.5	5 3.5	6 4.5	11 8	8 4	10 5	14 6.5



KLINGON EMPIRE



BEAM WEAPON TYPES

Disruptor Weapon Type	Total Mass (mt)	Maximum Beam Power	Disruptor Damage Modifiers			Maximum Range (hex)	Firing Chart	Weapon Damage Factor	SS Requirement (single/bank)	Availability	Cost (MCr)
			+3	+2	+1						
KD-1	150	4	-	-	-	10	B	0.7	0.3/0.6	RR1/61	46
KD-2	180	4	-	-	(1-10)	10	G	1.4	0.4/0.8	RR1/57	54
KD-3	210	5	-	-	(1-12)	12	I	2.7	0.6/1.2	III/48	64
KD-4	450	4	-	-	(1-10)	10	J	2.0	0.6/1.2	III/52	136
KD-5	575	4	-	(1-10)	(11-18)	18	P	3.1	0.8/1.6	III/38	172
KD-6	600	6	-	(1-18)	-	18	T	5.1	0.9/1.8	III/35	180
KD-7	350	7	-	(1-6)	(7-12)	12	L	3.8	1.1/2.2	III/46	106
KD-8	800	7	(1-7)	(8-15)	(16-20)	20	U	6.1	1.6/3.2	III/31	240
KD-9	600	5	(1-7)	(8-15)	(16-20)	20	W	5.0	1.3/2.6	III/30	182
KD-10	300	3	-	-	(1-6)	6	C	0.7	0.5/1.0	RR1/60	90
KD-11	340	5	-	(1-4)	(5-8)	8	F	1.7	0.6/1.2	III/56	102
KD-12	700	9	(1-3)	(4-8)	(9-10)	10	H	3.7	1.0/2.0	III/52	210
KD-13	520	5	(1-7)	(8-15)	(16-22)	22	X	5.7	1.6/3.2	III/28	156
KD-14	660	8	-	(1-6)	-	6	D	2.1	0.6/1.2	III/55	200

MISSILE WEAPON TYPES

Missile Weapon Type	Total Mass (mt)	Power To Arm	Damage	Maximum Range (hex)	Firing Chart	Weapon Damage Factor	SS Requirement	Availability	Cost (MCr)
KP-1	225	1	6	8	F	1.5	0.8	III/55	80
KP-2	375	1	10	10	H	3.3	1.0	III/51	120
KP-3	550	2	15	16	R	4.5	1.0	III/45	200
KP-4	675	2	18	14	Q	4.9	1.3	III/41	210
KP-5	300	1	10	14	Q	5.5	1.2	III/50	120
KP-6	600	2	20	16	R	5.9	1.6	III/38	240

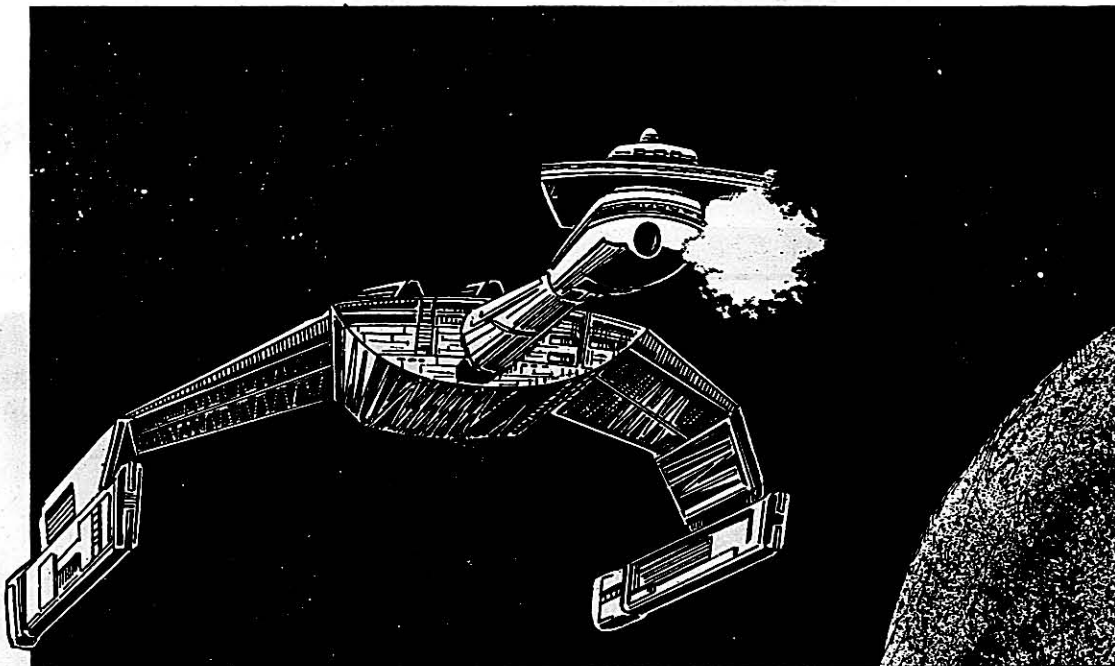



CONTROL COMPUTER SYSTEM TYPES						
Control Computer Type	System Mass (mt)	Appropriate Ship Classes	SS Requirement	Maximum WDF Allowed	Availability	Cost (MCr)
R1M	60	I - III	0.1	3	LLL/43	6
R2M	680	II - IX	0.5	8	LLL/39	24
R3M	1950	II - X	0.8	25	LLL/32	34
R4M	3170	III - XII	1.0	50	LLL/28	70
R5M	5250	VI - XV	1.8	75	LLL/14	100
R6M	8100	X - XIX	2.1	105	LLL/05	230

CONTROL COMPUTER SUITABILITY									
Control Computer Type	Single Warp Engine Type		Tandem Warp Engine Type	Impulse Engine Type		Deflector Shield Generator Type		Cloaking Device Type	Maximum WDF Allowed
R1M	RWA		—	RIA		RSA		None	3
				RIB		RSB			
				RIC					
				RID-1					
R2M	RWA	RWD-1	RWA-1	RIA	RIDF	RSA	RSD	None	8
	RWB	RWE		RIB	RIE-1	RSB	RSG		
	RWC			RIC		RSC			
R3M	RWA	RWD	RWA	RIA	RIE	RSA	RSE	RCA	25
	RWB	RWE	RWB-1	RIB	RIF-1	RSB	RSG	RCB	
	RWC	RWF		RIC	RIF-2	RSC	RSJ		
						RSM			
R4M	All		RWA	All	RSA	RSG		RCA	50
			RWB		RSB	RSH		RCB	
			RWC		RSC	RSJ		RCC	
			RWD-1		RSD	RSK			
			RWE		RSE	RSM			
			RWF-1		RSF				
R5M	All		All	All	All But RSL, RSO	RCA		RCC	75
						RCB		RCD	
R6M	All		All	All		All		All	105

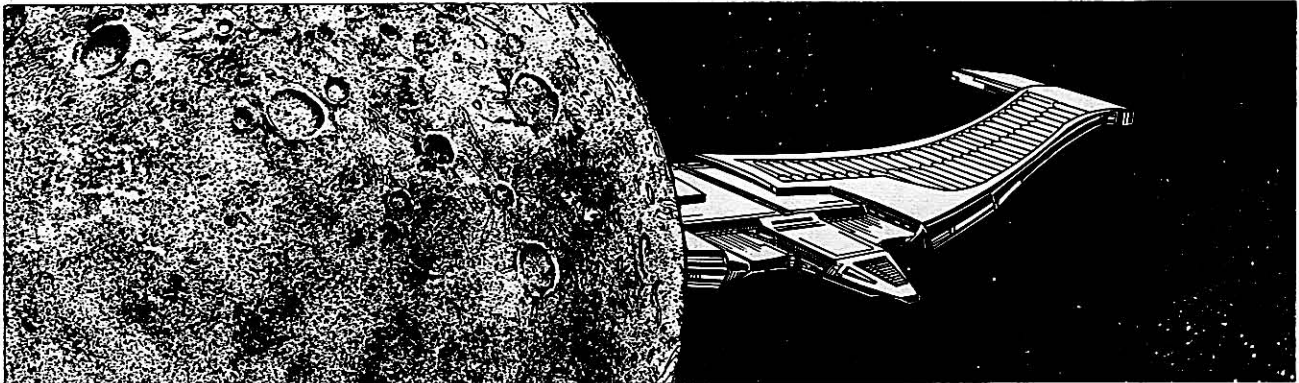



CLOAKING DEVICE TYPES

Cloaking Device Type	Appropriate Ship Classes	Power To Energize	Control Computer Requirement	SS Requirement	Availability	Cost (MCr)
RCA	II - III	8	R2M	None	III/05	12,000
RCB	IV - V	10	R3M	None	III/04	20,000
RCC	VI - IX	15	R4M	None	III/02	45,000
RCD	X - XI	22	R5M	None	III/01	70,000
RCE	XII	38	R5M	None	III/01	90,000

WARP ENGINE TYPES
Single Engine Use

Warp Engine Type	Total Mass (mt)	Power Units Available	Control Computer Requirement	Stress Column (Eng/SS)	SS Requirement	Availability	Cost (MCr)
RWA-1	3,000	6	R1M	K/M	0.2	RRR/48	4.2
RWA-2	2,800	8	R1M	J/L	0.2	RRR/44	5.0
RWB-1	8,000	10	R2M	K/O	0.6	RRR/44	7.2
RWB-2	8,200	9	R2M	L/O	0.6	RRR/40	8.5
RWC-1	20,000	12	R2M	K/O	1.6	RRR/39	49
RWC-2	20,000	14	R2M	L/P	1.6	RRR/35	50
RWD-1	30,000	15	R2M	N/O	2.4	RRR/32	145
RWD-2	30,000	18	R3M	O/Q	2.4	RRR/28	192
RWE-1	40,000	12	R2M	H/J	3.2	RRR/26	206
RWF-1	50,000	16	R3M	F/K	4.0	RRR/21	312
RWF-2	50,000	18	R3M	F/L	4.0	RRR/18	322
RWG-1	70,000	22	R4M	D/F	5.6	RRR/15	497
Tandem Engine Use							
Warp Engine Type	Total Mass (mt)	Power Units Available	Control Computer Requirement	Stress Column (Eng/SS)	SS Requirement	Availability	Cost (MCr)
RWA-1	6,000	6 ea	R2M	M/O	0.4	RRR/48	9.6
RWA-2	5,600	9 ea	R3M	J/M	0.4	RRR/44	11.0
RWB-1	16,000	10 ea	R3M	M/P	1.2	RRR/44	15.4
RWB-2	16,400	11 ea	R4M	N/P	1.2	RRR/40	18.7
RWC-1	40,000	12 ea	R4M	M/P	3.2	RRR/39	107
RWC-2	40,000	15 ea	R4M	N/Q	3.2	RRR/35	110
RWD-1	60,000	16 ea	R4M	O/O	4.8	RRR/32	319
RWD-2	60,000	20 ea	R5M	O/O	4.8	RRR/28	422
RWE-1	80,000	13 ea	R4M	I/L	6.4	RRR/26	453
RWF-1	100,000	18 ea	R4M	G/L	8.0	RRR/21	686
RWF-2	100,000	20 ea	R5M	G/M	8.0	RRR/18	708
RWG-1	140,000	24 ea	R5M	G/L	11.2	RRR/15	10,95



ROMULAN STAR EMPIRE



IMPULSE ENGINE TYPES							
Engine Type	Total Mass (mt)	Power Units Available	Control Computer Requirement	Ship Classes Powered	SS Requirement	Availability	Cost (MCr)
RIA-1	188	1	R1M	I	0.1	RRR/44	10
RIA-2	188	2	R1M	I-II	0.1	RRR/42	17
RIA-3	188	3	R1M	I-II	0.1	RRR/40	26
RIB-1	263	2	R1M	II-VII	0.1	RRR/40	20
RIB-2	263	3	R1M	III-IX	0.1	RRR/37	30
RIB-3	263	5	R1M	IV-IX	0.1	RRR/34	48
RIC-1	505	1	R1M	II-V	0.1	RRR/35	21
RIC-2	505	4	R1M	IV-VIII	0.1	RRR/32	31
RIC-3	505	5	R1M	VIII-X	0.1	RRR/29	50
RIC-4	505	6	R1M	X-XIII	0.1	RRR/23	60
RID-1	700	4	R1M	VII-XIII	0.1	RRR/29	34
RID-2	700	8	R2M	VIII-XIII	0.1	RRR/26	62
RID-3	700	12	R2M	V-XIII	0.1	RRR/21	117
RIE-1	788	10	R2M	V-XIV	0.1	RRR/22	104
RIE-2	788	15	R3M	VII-XVII	0.1	RRR/18	151
RIE-3	788	20	R3M	X-XVIII	0.1	RRR/14	178
RIF-1	900	12	R3M	XII-XIX	0.1	RRI/12	122
RIF-2	900	18	R3M	XII-XIX	0.1	RRI/10	202
RIF-3	900	28	R4M	XIII-XIX	0.1	RRI/04	306





ROMULAN STAR EMPIRE



MOVEMENT POINT RATIO TABLE: SINGLE WARP ENGINE											
Ship Class	Movement Point Ratios										
	1/3	1/2	1/1	2/1	3/1	4/1	5/1	6/1			
I	RWA-1 25.5 7/8 RWA-2 34 7/8	RWA-2 23 7/8	RWA-2 11.5 7/8								
II		RWA-1 17 7/8	RWA-2 11.5 7/8 RWB-1 14 8/7 RWB-2 13 8/7								
III			RWA-1 8.5 6/7	RWA-1 4 5/6 RWA-2 5.5 6/7 RWB-1 7 5/6	RWB-2 6.5 6/7 RWC-1 8.5 6/8 RWC-2 10 6/8						
IV				RWC-1 8.5 6/8 RWC-2 10 6/8	RWD-1 11 7/8 RWD-2 13 7/8	RWC-1 5.5 5/7					
V				RWD-1 11 7/8 RWD-2 13 7/8		RWC-2 6.5 5/7 RWE-1 6 7/8	RWF-1 7.5 7/9 RWF-2 8.5 7/9				
VI				RWD-1 11 7/8 RWD-2 13 7/8		RWD-1 7 8/7 RWD-2 8.5 8/7 RWE-1 6 7/8	RWF-1 7.5 7/9 RWF-2 8.5 7/8				
VII						RWD-1 7 6/7 RWD-2 8.5 6/7 RWE-1 6 7/8	RWF-1 7.5 7/9 RWF-2 8.5 7/8	RWD-1 5 5/6 RWD-2 6 5/6			
VIII						RWE-1 6 7/8 RWF-1 7.5 7/9	RWF-2 8.5 7/8	RWD-1 5 5/6 RWD-2 6 5/6	RWG-1 7.5 7/8		
IX						RWE-1 6 7/8 RWF-1 7.5 7/9 RWF-2 8.5 7/8	RWD-1 5 5/6 RWD-2 6 6/7 RWE-1 4 6/7	RWF-1 6 6/8 RWF-2 6 6/7 RWG-1 7.5 7/9	RWG-1 6 6/8		
X							RWE-1 4 6/7 RWF-1 6 6/8	RWF-2 6 6/7	RWD-2 5 4.5 RWG-1 6 6/8		
XI							RWE-1 4 6/7	RWF-1 6 6/8	RWG-1 6 6/8		
XII							RWE-1 4 6/7	RWF-1 6 6/8	RWF-1 4.5 5/7	RWG-1 6 6/8	
XIII									RWE-1 3 5/6	RWF-1 4.5 5/7	RWG-1 5 5/7
XIV									RWE-1 3 5/6	RWF-1 4.5 5/7	RWG-1 5 5/7
XV									RWE-1 3 5/6	RWF-1 4.5 5/7	RWG-1 5 5/7



MOVEMENT POINT RATIO TABLE: TANDEM WARP ENGINES

Movement Point Ratios

Ship Class	1/1	3/2	2/1	3/1	4/1	5/1	6/1	7/1	
II	RWA-1 34 7/8	RWA-1 17 6/7 RWA-2 25.5 6/7							
III		RWA-2 25.5 6/7 RWB-1 28.5 6/7 RWB-2 31.5 6/7	RWA-1 8.5 5/6 RWB-1 14 6/7						
IV			RWA-2 13 5/6 RWB-1 14 6/7 RWB-2 15.5 6/7	RWA-1 5.5 4/5 RWB-1 9.5 5/6 RWB-2 10.5 5/6					
V			RWC-1 17 5/7 RWC-2 21.5 6/8 RWD-1 23 7/8	RWB-2 10.5 5/6 RWC-1 11.5 4/6 RWC-1 11.5 4/6 RWC-2 14 6/7	RWC-2 14 6/7				
VI			RWD-1 23 7/8	RWD-1 15.5 6/7	RWD-2 19 7/8	RWD-2 19 7/8	RWC-2 11 4/6		
VII				RWE-1 12 7/8 RWD-1 15.5 6/7	RWE-1 12 7/8	RWC-2 11 4/6			
VIII				RWD-1 15.5 6/7 RWE-1 12 7/8		RWD-2 14 6/7 RWF-1 13 7/9	RWF-2 14 7/8		
IX				RWD-1 15.5 6/7		RWD-2 14 6/7 RWE-1 9 6/7	RWF-1 13 7/9 RWF-2 14 7/8		
X				RWD-1 15.5 6/7		RWD-1 11.5 5/6 RWD-2 14 6/7 RWE-1 9 6/7	RWF-1 13 7/9 RWF-2 14 7/8 RWG-1 17 7/9	RWD-2 11.5 5/6	
XI						RWD-1 11.5 5/6 RWE-1 9 6/7 RWF-1 13 7/9	RWF-2 14 7/8 RWG-1 17 7/9	RWD-2 11.5 5/6	
XII						RWD-1 11.5 5/6 RWE-1 9 6/7 RWF-1 13 7/9	RWF-2 14 7/8 RWG-1 17 7/9 RWF-1 10 6/8	RWD-2 11.5 5/6 RWF-2 6/7	
XIII						RWG-1 17 7/9	RWD-1 9 4/5 RWE-1 7 5/6 RWF-1 10 6/8	RWF-2 11.5 6/7 RWG-1 13.5 6/8 RWD-2 9.5 4/5	
XIV							RWD-1 9 4/5 RWE-1 7 5/6 RWF-1 10 6/8	RWF-2 11.5 6/7 RWG-1 13.5 6/8 RWD-2 9.5 4/5	
XV							RWD-1 9 4/5	RWD-2 9.5 4/5 RWE-1 7 5/6 RWF-1 11 5/7	RWF-1 8.5 5/7 RWG-1 11 5/7
XVI							RWD-1 9 4/5	RWD-2 9.5 4/5 RWE-1 6 4/5	RWF-1 8.5 5/7 RWG-1 9.5 4/6
XVII							RWD-1 9 4/5	RWE-1 6 4/5	RWD-2 8 3/4 RWF-1 7 4/6 RWG-1 9.5 4/6
XVIII								RWD-2 8 3/4 RWF-1 7 4/6	RWG-1 9.5 4/6
XIX								RWD-2 8 3/4	RWF-1 7 4/6

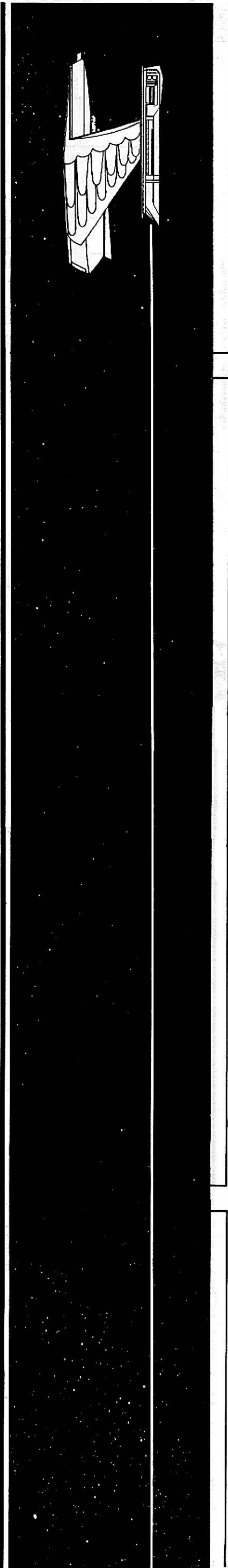
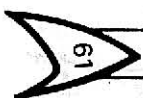
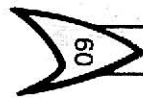



MOVEMENT POINT RATIO TABLE: IMPULSE ENGINE

Ship Class	Movement Point Ratios														
	1/3	1/2	1/1	2/1	3/1	4/1	5/1	6/1	7/1						
I	RIA-1 4 RIA-2 8.5	RIA-1 3 RIA-2 6 RIA-3 8.5	RIA-1 1.5 3 RIA-3 4												
II		RIA-2 6 RIA-3 8.5	RIA-2 3 RIA-3 4 RIB-1 3 RIC-1 1.5												
III			RIB-1 3 RIB-2 4 RIC-1 1.5	RIB-1 1.5 RIB-2 2 RIB-3 3.5 RIC-1 1											
IV				RIB-1 1.5 RIB-2 2	RIB-3 3.5 RIC-1 1	RIB-1 1 RIC-1 1									
V				RIB-1 1.5 RIB-2 2 RIB-3 3.5	RIC-2 2 RID-3 8.5	RIB-1 1 RIB-2 1.5 RIB-3 2.5	RIC-1 0.5 RIC-2 1.5 RIE-1 4.5								
VI				RIB-1 1.5 RIB-2 2 RIB-3 3.5	RIC-2 2 RID-3 8.5	RIB-1 1 RIB-2 1.5 RIB-3 2.5	RIC-2 1.5 RIE-1 4.5 RIB-3 2 RIC-2 1								
VII				RIB-1 1.5 RIB-2 2 RIC-2 2	RID-3 8.5	RIB-1 1 RIB-2 1.5 RIB-3 2.5	RIC-2 1.5 RID-1 2 RIE-1 4.5 RIC-2 1	RIE-1 3.5							
VIII						RIB-2 1.5 RIC-3 2.5 RID-1 2	RID-3 5.5	RIB-3 2 RIC-2 1 RIC-3 2	RIE-1 3.5 RIE-2 5						
IX						RIB-2 1.5 RIC-3 2.5 RID-1 2	RID-2 3.5 RID-3 5.5	RIC-3 2 RID-1 1.5 RID-2 3	RID-3 4 RIE-1 3.5 RIE-2 5	RIC-3 1.5 RIE-1 3					
X						RIC-3 2.5 RIC-4 3 RID-2 3.5 RID-3 5.5		RIC-3 2 RIC-4 2 RID-1 1.5 RID-2 3	RID-3 4 RIE-2 5 RIE-3 6	RIC-3 1.5 RIC-4 1.5 RID-1 1 RIE-1 3	RIE-2 4				
XI								RIC-4 2 RID-1 1.5 RID-2 3 RID-3 4	RIE-2 5 RIE-3 6	RIC-4 1.5 RID-1 1 RID-2 2 RID-3 3.5	RIE-1 3 RIE-2 4 RIE-3 5.5				
XII								RIC-4 2 RID-1 1.5 RID-2 3	RIE-3 6 RIF-1 4	RIC-4 1.5 RID-1 1 RID-2 2 RID-3 3.5	RIE-1 3 RIE-2 4 RIE-3 5.5				
XIII								RIF-1 4 RIF-2 6.5		RIF-1 3.5 RIF-2 5 RIE-2 4 RIE-3 5.5	RID-2 2 RID-3 3.5 RIF-3 8	RIE-2 3.5 RIE-3 5 RID-2 2 RIE-1 2.5 RIE-3 5	RIC-4 1.5 RID-1 1 RIF-1 3 RIF-2 4		
XIV										RIF-1 3.5 RIF-2 5 RIF-3 8		RIE-1 2.5 RIE-2 3.5 RIE-3 5	RIE-1 3 RIF-2 4		
XV										RIF-1 3.5 RIF-2 5 RIF-3 8		RIE-2 3.5 RIE-3 5 RIF-1 3	RIF-2 4 RIF-3 6	RIE-2 3 RIE-3 4 RIF-1 2.5	RIF-2 3.5 RIF-3 5.5
XVI												RIE-2 3.5 RIE-3 5 RIF-1 3	RIF-2 4 RIF-3 6	RIE-2 3 RIE-3 4 RIF-1 2.5	RIF-2 3.5 RIF-3 5.5
XVII													RIE-2 3 RIE-3 4 RIF-1 2.5	RIE-2 3.5 RIF-3 5.5	
XVIII													RIF-1 2.5 RIF-2 3.5	RIF-3 5.5	
XIX													RIF-1 2.5 RIF-2 3.5	RIF-3 5.5	

62

63





SHIELD GENERATOR TYPES

Shield Generator Type	Total Mass (mt)	Control Computer Requirement	Shield Efficiency Rating	SS Requirement	Availability	Cost (MCr)
RSA	105	R1M	1	0.2	LRL/35	3
RSB	145	R1M	1	0.3	LRL/33	5
RSC	205	R2M	2	0.9	LRL/22	10
RSD	170	R2M	1	0.5	LRL/32	6
RSE	235	R3M	2	1.1	LRL/21	15
RSF	330	R4M	3	1.9	LRL/15	19
RSG	230	R2M	1	0.7	LRL/29	8
RSH	320	R4M	2	1.4	LRL/20	18
RSI	450	R5M	3	2.0	LRL/12	25
RSJ	270	R3M	1	0.8	LRL/28	10
RSK	380	R4M	2	1.9	LRL/17	21
RSL	530	R6M	3	2.1	LRL/11	29
RSM	315	R3M	1	0.9	LRL/27	11
RSN	440	R5M	2	2.0	LRL/16	24
RSO	615	R6M	3	2.4	LRL/10	35

MAXIMUM SHIELD POWER

Shield Types/Shield Point Ratios

Ship Class	1/1						1/2					1/3			
	RSA	RSB	RSD	RSG	RSJ	RSM	RSC	RSE	RSH	RSK	RSN	RSF	RSI	RSL	RSO
I	5	9	12	15	15	15	12	14	15	15	15	15	15	15	15
	7	13	17	21.5	21.5	21.5	8.5	10	10.5	10.5	10.5	7	7	7	7
II	5	8	10	14	15	15	10	13	15	15	15	15	15	15	15
	7	11.5	14.5	20	21.5	21.5	7	9.5	10.5	10.5	10.5	7	7	7	7
III	5	7	9	14	15	15	8	12	14	15	15	13	15	15	15
	7	10	13	20	21.5	21.5	5.5	8.5	10	10.5	10.5	6	7	7	7
IV	4	7	8	14	15	15	7	10	13	15	15	10	15	15	15
	5.5	10	11.5	20	21.5	21.5	5	7	9.5	10.5	10.5	5	7	7	7
V	4	6	8	13	14	15	6	8	11	14	15	8	14	15	15
	5.5	8.5	11.5	18.5	20	21.5	4	5.5	8	10	10.5	4	6.5	7	7
VI	3	5	7	13	14	15	5	8	11	14	15	8	14	15	15
	4.5	7	10	18.5	20	21.5	3.5	5.5	8	10	10.5	4	6.5	7	7
VII	3	4	7	12	14	15	5	7	10	14	15	7	12	15	15
	4.5	5.5	10	17	20	21.5	3.5	5	7	10	10.5	3.5	5.5	7	7
VIII	2	3	7	11	13	15	5	6	8	13	15	7	11	15	15
	3	4.5	10	15.5	18.5	21.5	3.5	4	5.5	9.5	10.5	3.5	5	7	7
IX	1	2	6	10	13	15	4	5	6	13	15	6	11	14	15
	1.5	3	8.5	14.5	18.5	21.5	3	3.5	4	9.5	10.5	3	5	6.5	7
X	1	1	6	9	13	15	3	5	6	12	15	6	10	14	15
	1.5	1.5	8.5	13	18.5	21.5	2	3.5	4	8.5	10.5	3	5	6.5	7
XI	—	1	5	7	12	13	2	4	5	12	15	5	8	13	15
	—	1.5	7	10	17	18.5	1.5	3	3.5	8.5	10.5	2.5	4	6	7
XII	—	—	4	5	10	11	2	3	5	11	15	5	7	13	15
	—	—	5.5	7	14.5	15.5	1.5	2	3.5	8	10.5	2.5	3.5	6	7
XIII	—	—	2	3	8	9	1	2	4	10	15	4	6	12	15
	—	—	3	4.5	11.5	13	0.5	1.5	3	7	10.5	2	3	5.5	7
XIV	—	—	1	2	6	7	—	1	3	8	13	4	5	11	15
	—	—	1.5	3	8.5	10	—	0.5	2	5.5	9.5	2	2.5	5	7
XV	—	—	—	1	3	5	—	—	3	7	10	4	5	10	14
	—	—	—	1.5	4.5	7	—	—	2	5	7	2	2.5	5	6.5



BEAM WEAPON TYPES

Beam Weapon Type	Total Mass (mt)	Maximum Beam Power	Damage Modifiers			Maximum Range (hex)	Firing Chart	Weapon Damage Factor	SS Requirement (single/bank)	Availability	Cost (MCr)
			+3	+2	+1						
RB-1	200	2	-	-	-	10	G	0.5/0.8	0.5/0.8	RRI/46	45
RB-2	225	2	-	-	-	15	K	0.8/1.2	0.6/0.9	RRI/44	51
RB-2a	400	3	(1-4)	(5-9)	(10-14)	15	K	2.1/3.2	0.8/1.2	III/30	120
RB-3	600	6	-	-	(1-4)	4	A	0.8/1.2	0.3/0.5	RRI/40	135
RB-3a	750	6	(1-3)	(4-8)	(9-12)	12	L	3.7/5.6	0.7/1.0	III/38	165
RB-4	650	6	(1-2)	(3-6)	(7-10)	10	J	3.2/4.8	0.6/0.9	III/34	142
RB-5	750	5	(1-10)	(11-16)	(17-21)	21	V	4.7/7.1	1.5/2.3	III/18	168
RB-6	650	6	-	(1-18)	-	18	T	5.1/7.7	1.3/1.9	III/28	146
RB-7	500	4	-	(1-6)	(7-10)	10	J	2.3/3.5	0.6/0.9	III/35	100
RB-7a	675	4	(1-3)	(4-9)	(10-14)	14	M	3.0/4.5	0.9/1.2	III/18	150
RB-8	600	6	(1-4)	(5-9)	(10-13)	13	N	4.1/6.2	1.0/1.5	III/31	140
RB-9	700	6	(1-8)	(9-16)	(17-20)	20	W	6.5/9.8	1.5/2.3	III/24	162
RB-10	750	8	(1-8)	(9-16)	(17-20)	20	U	6.9/10.4	1.6/2.4	III/22	183
RB-11	850	9	(1-10)	(11-16)	(17-21)	21	V	7.9/11.9	1.8/2.8	III/16	210

MISSILE WEAPON TYPES

Missile Weapon Type	Total Mass (mt)	Power To Arm	Damage	Maximum Range (hex)	Firing Chart	Weapon Damage Factor	SS Requirement	Availability	Cost (MCr)
RP-1	135	1	6	8	F	1.5/2.3	0.8	III/36	34
RP-2	180	1	8	10	H	2.4/3.6	1.0	III/32	45
RP-3	225	1	10	14	Q	5.5/8.3	1.2	III/28	55

PLASMA WEAPON TYPES

Plasma Weapon Type	Total Mass (mt)	Power To Arm	Weapon Damage Chart	Maximum Range (hex)	Firing Chart	Weapon Damage Factor	SS Requirement	Availability	Cost (MCr)
RPL-1	120	10	RL-1	8	E	3.9/5.8	2.1	III/28	270
RPL-2	180	15	RL-2	14	M	11.1/16.6	3.4	III/24	500
RPL-3	150	8	RL-3	18	T	13.7/20.5	2.5	III/31	325

TOTAL DAMAGE FROM ROMULAN PLASMA WEAPONS

Range	RL-1	RL-2	RL-3
1	24/12	32/16	28/14
2	20/10	32/16	28/14
3	20/10	32/16	28/14
4	16/8	24/12	28/14
5	16/8	24/12	24/12
6	12/6	24/12	24/12
7	8/4	20/10	24/12
8	4/2	20/10	24/12
9	—	16/8	20/10
10	—	16/8	20/10
11	—	12/6	20/10
12	—	12/6	16/8
13	—	8/4	16/8
14	—	8/4	12/6
15	—	—	12/6





ORION COLONIES



CONTROL COMPUTER SYSTEM TYPES

Control Computer Type	System Mass (mt)	Appropriate Ship Classes	SS Requirement	Maximum WDF Allowed	Availability	Cost (MCr)
Mark I	40	I-III	0.1	2	LLL/68	3
Mark II	320	II-VI	0.3	8	LLL/63	9
Mark III	860	II-X	0.5	22	LLL/59	22
Mark IV	2750	III-X	1.0	40	LLL/52	50

CONTROL COMPUTER SUITABILITY

Control Computer Type	Single Warp Engine Type	Tandem Warp Engine Type	Impulse Engine Type	Deflector Shield Generator Type	Maximum WDF Allowed
Mark I	OWB OWC		OIA OIB-1	OSA OSB OSD OSE OSG	2
Mark II	OWB OWC OWD OWE	OWC	All	OSA OSB OSC OSD OSE OSG OSH	8
Mark III	All	All But OWA	All	All but OSJ	22
Mark IV	All	All	All	All	40

WARP ENGINE TYPES

Warp Engine Type	Total Mass (mt)	Power Units Available	Single Engine Use		SS Requirement	Availability	Cost (MCr)
			Control Computer Requirement	Stress Column (Eng/SS)			
OWA-1	6,000	15	Mark III	E/D	0.5	RRR/55	65
OWA-2	6,000	17	Mark III	F/D	0.5	RRR/50	85
OWB-1	1,400	8	Mark I	C/D	0.2	RRR/65	20
OWC-1	3,000	6	Mark I	E/E	0.4	RRR/60	38
OWD-1	10,000	12	Mark II	J/L	1.0	RRR/57	200
OWE-1	8,000	10	Mark II	J/K	0.8	RRR/54	175
Warp Engine Type	Total Mass (mt)	Power Units Available	Tandem Engine Use		SS Requirement	Availability	Cost (MCr)
			Control Computer Requirement	Stress Column (Eng/SS)			
OWA-1	12,000	15 ea	Mark IV	G/F	1.0	RRR/55	145
OWA-2	12,000	17 ea	Mark IV	G/F	1.0	RRR/50	180
OWB-1	2,800	9 ea	Mark III	D/F	0.4	RRR/65	45
OWC-1	6,000	6 ea	Mark II	E/F	0.8	RRR/60	80
OWD-1	20,000	12 ea	Mark III	K/M	2.0	RRR/57	440
OWE-1	16,000	10 ea	Mark III	K/L	1.6	RRR/64	390

MOVEMENT POINT RATIO TABLE:

SINGLE WARP ENGINE

Ship Class	Movement Point Ratios				
	1/2	1/1	2/1	3/1	4/1
I	OWB-1 23 5/8 OWC-1 17 7/8	OWB-1 11.5 4/7	OWB-1 5.5 4/6		
II		OWA-1 21.5 8/10 OWA-2 24.5 8/10 OWC-1 8.5 6/7	OWA-1 10.5 8/9 OWA-2 12 7/9 OWB-1 5.5 4/6		
III			OWA-2 12 7/9 OWC-1 4 5/7 OWD-1 8.5 6/8 OWE-1 7 6/7	OWA-1 7 7/8 OWA-2 8 6/8	
IV				OWA-2 8 6/8 OWD-1 5.5 6/7 OWE-1 5 6/7	
V				OWD-1 5.5 6/7 OWE-1 5 6/7	
VI					OWD-1 4 5/6 OWE-1 3.5 5/6



ORION COLONIES

MOVEMENT POINT RATIO TABLE:

TANDEM WARP ENGINES

Ship Class	Movement Point Ratios			
	1/1	2/1	3/1	4/1
II	OWC-1 17 7/8	OWB-1 13 6/9		
III	OWA-2 46 8/10	OWA-1 21.5 8/10 OWA-2 24.5 7/9 OWB-1 13 6/9 OWC-1 8.5 6/8	OWA-1 14.5 8/10	
IV		OWA-2 24.5 6/8 OWD-1 17 6/8 OWE-1 14 7/8	OWA-1 14.5 8/10 OWB-1 8 5/8 OWC-1 5.5 5/7	OWA-1 10.5 7/9
V		OWD-1 17 6/8 OWA-2 24.5 6/8	OWA-2 16 7/8 OWE-1 9.5 6/7	OWA-1 10.5 7/9 OWB-1 5.5 5/7
VI		OWD-1 17 6/8	OWD-1 11.5 6/7 OWE-1 9.5 6/7	OWA-2 12 6/7
VII			OWD-1 11.5 6/7	OWE-1 7 5/6
VIII			OWD-1 11.5 6/7	OWE-1 7 5/6
IX			OWD-1 11.5 6/7	OWD-1 8.5 5/7
X				OWD-1 8.5 5/7



ORION COLONIES



IMPULSE ENGINE TYPES							
Engine Type	Total Mass (mt)	Power Units Available	Control Computer Required	Ship Classes Powered	SS Requirement	Availability	Cost (Mcr)
OIA-1	23	1	Mark I	I	0.1	RRR/75	10
OIA-2	23	2	Mark II	I-II	0.1	RRR/70	19
OIA-3	23	3	Mark II	I-II	0.1	RRR/68	28
OIB-1	75	1	Mark I	III-IV	0.1	RRR/70	12
OIB-2	75	2	Mark II	IV-V	0.1	RRR/65	22
OIB-3	75	3	Mark II	IV-VI	0.1	RRR/60	33
OIC-1	200	2	Mark II	V	0.1	RRR/63	26
OIC-2	200	4	Mark II	V-VII	0.1	RRR/58	32
OIC-3	200	6	Mark III	VIII-X	0.1	RRR/52	45

Ship Class	Movement Point Ratios				
	1/2	1/1	2/1	3/1	4/1
I	OIA-1 3 OIA-2 5.5 OIB-1 3	OIA-1 1.5 OIA-2 3 OIB-1 1.5	OIA-1 0.5 OIA-2 1.5 OIA-3 2 OIB-1 0.5		
II		OIA-2 3 OIB-1 1.5	OIA-2 1.5 OIA-3 2 OIB-1 0.5		
III		OIB-1 1.5	OIB-1 0.5	OIB-1 0.5	
IV			OIB-1 0.5 OIB-2 1.5 OIB-3 2	OIB-1 0.5 OIB-2 1 OIB-3 1.5	OIB-2 0.5
V			OIB-2 1.5 OIB-3 2 OIC-1 1.5 OIC-2 3	OIB-2 1 OIB-3 1.5 OIC-1 1 OIC-2 2	OIB-2 0.5 OIB-3 1 OIC-2 1.5
VI			OIB-3 2 OIC-2 3	OIB-3 1.5 OIC-2 2	OIB-3 1 OIC-2 1.5
VII				OIC-2 2	OIC-2 1.5
VIII				OIC-3 3	OIC-3 2
IX				OIC-3 3	OIC-3 2
X					OIC-3 2



SHIELD GENERATOR TYPES

Shield Generator Type	Total Mass (mt)	Control Computer Requirement	Shield Efficiency Rating	SS Requirement	Availability	Cost (Mcr)
OSA-1	60	Mark I	1	0.2	LRL/60	1
OSB-2	85	Mark I	2	0.5	LRL/55	2
OSC-3	125	Mark II	3	1.0	LRL/47	8
OSD-1	100	Mark I	1	0.2	LRL/59	2
OSE-2	140	Mark I	2	0.6	LRL/54	3
OSF-3	205	Mark III	3	1.8	LRL/46	10
OSG-1	185	Mark I	1	0.4	LRL/58	3
OSH-2	255	Mark II	2	1.0	LRL/53	4
OSI-3	365	Mark III	3	2.0	LRL/45	15
OSJ-4	480	Mark IV	4	2.5	LRL/44	25

MAXIMUM SHIELD POWER
Shield Types/Shield Point Ratios

Ship Class	1/1			1/2			1/3			1/4
	OSA	OSD	OSG	OSB	OSE	OSH	OSC	OSF	OSI	OSJ
I	4 5.5	6 8.5	8 11.5	7 5	8 5.5	8 5.5	8 4	8 4	12 5.5	12 4.5
II	4 5.5	5 7	6 8.5	6 4.5	7 5	8 5.5	7 3.5	7 3.5	11 5	12 4.5
III	3 4.5	4 5.5	5 7	5 3.5	6 4.5	7 5	6 3	6 3	9 4.5	10 3.5
IV	2 3	3 4.5	4 5.5	3 2	5 3.5	7 5	5 2.5	6 3	8 4	8 3
V	1 1.5	2 3	3 4.5	2 1.5	4 3	6 4.5	4 2	5 2.5	7 3.5	8 3
VI	— —	1 1.5	2 3	2 1.5	3 2	5 3.5	4 2	5 2.5	7 3.5	8 3
VII	— —	— —	1 1.5	1 0.5	2 1.5	3 2	3 1.5	4 2	6 3	7 2.5
VIII	— —	— —	— —	— —	1 0.5	2 1.5	1 0.5	3 1.5	6 3	7 2.5
IX	— —	— —	— —	— —	— —	1 0.5	— —	2 1	5 2.5	6 2
X	— —	— —	— —	— —	— —	— —	— —	1 0.5	4 2	6 2

DISRUPTOR BEAM WEAPON TYPES

Disruptor Weapon Type	Total Mass (mt)	Maximum Beam Power	Damage Modifiers		Maximum Range (hex)	Firing Chart	Weapon Damage Factor	SS Requirement	Availability	Cost (Mcr)
			+2	+1						
OD-1	60	3	—	—	8	E	0.6	0.2/0.3	RRR/72	9
OD-2	80	3	(1-5)	(6-10)	10	J	1.9	0.4/0.6	RRR/68	12
OD-3	150	4	—	(1-16)	16	R	3.0	0.8/1.5	RRR/63	23
OD-4	180	6	(1-18)	—	18	T	5.2	1.2/2.0	RRR/58	27
OD-5	210	7	(1-10)	(11-20)	20	U	5.8	1.8/3.0	RRR/54	32



GORN ALLIANCE



CONTROL COMPUTER SYSTEM TYPES

Control Computer Type	System Mass (mt)	Appropriate Ship Classes	SS Requirement	Maximum WDF Allowed	Availability	Cost (Mcr)
1AG	45	I-II	0.2	5	None	N/A
1BG	515	II-VI	0.8	10	None	N/A
1CG	1,400	II-X	1.3	20	None	N/A
1DG	3,350	IV-XIV	2.1	40	None	N/A
1EG	6,800	IX-XVII	2.9	80	None	N/A

CONTROL COMPUTER SUITABILITY

Control Computer Type	Single Warp Engine Type	Tandem Warp Engine Type	Impulse Engine Type	Deflector Shield Generator Type	Maximum WDF Allowed
1AG	GWA-1		GIA GID-1 GIB GIE-1 GIC	GSA GSI GSC GSL GSF	5
1BG	GWA GWB GWC-1		All But GIE-3, GIF-3	GSA GSF GSB GSI GSC GSL GSD	10
1CG	GWA GWB GWC GWD GWE GWG	GWA GWB	All But GIF-3	GSA GSI GSB GSJ GSC GSL GSD GSM GSF GSG	20
1DG	All	All But GWE, GWF	All All But GSK, GSN		40
1EG	All	All	All	All	80

WARP ENGINE TYPES Single Engine Use

Warp Engine Type	Total Mass (mt)	Power Units Available	Control Computer Requirement	Stress Column (Eng/SS)	SS Requirement	Availability	Cost (Mcr)
GWA-1	3,500	8	1AG	Q/R	0.3	None	N/A
GWB-1	12,000	10	1BG	M/O	1.0	None	N/A
GWC-1	16,000	14	1BG	J/O	1.2	None	N/A
GWC-2	18,000	16	1CG	K/O	1.4	None	N/A
GWD-1	26,000	15	1CG	N/L	2.2	None	N/A
GWD-2	40,000	17	1CG	O/M	3.3	None	N/A
GWE-1	60,000	22	1CG	Q/R	5.0	None	N/A
GWF-1	72,000	24	1DG	M/N	6.0	None	N/A
GWG-1	34,000	14	1CG	N/M	2.8	None	N/A

Tandem Engine Use

Warp Engine Type	Total Mass (mt)	Power Units Available	Control Computer Requirement	Stress Column (Eng/SS)	SS Requirement	Availability	Cost (Mcr)
GWA-1	7,000	9 ea	1CG	Q/R	0.6	None	N/A
GWB-1	24,000	12 ea	1CG	O/P	2.0	None	N/A
GWC-1	32,000	16 ea	1DG	M/O	2.4	None	N/A
GWC-2	36,000	18 ea	1DG	M/P	2.8	None	N/A
GWD-1	52,000	16 ea	1DG	O/L	4.4	None	N/A
GWD-2	80,000	18 ea	1DG	Q/P	6.6	None	N/A
GWE-1	120,000	22 ea	1EG	Q/R	10.0	None	N/A
GWF-1	144,000	26 ea	1EG	M/O	12.0	None	N/A
GWG-1	68,000	15 ea	1DG	O/M	5.6	None	N/A



GORN ALLIANCE



MOVEMENT POINT RATIO TABLE: SINGLE WARP ENGINE

Movement Point Ratios

Ship Class	1/2	1/1	2/1	3/1	4/1	5/1	6/1	7/1
I	GWA-1 23 6/7	GWA-1 11.5 5/6						
II		GWA-1 11.5 5/6 GWB-1 14.5 6/7	GWA-1 5.5 5/6					
III		GWB-1 14.5 6/7	GWC-1 10 6/7	GWC-2 7.5 6/8				
IV			GWB-1 14.5 6/7 GWC-1 10 6/7	GWC-2 7.5 6/8	GWD-1 5.5 5/7			
V				GWC-1 6.5 5/6	GWC-2 5.5 5/7	GWD-1 5.5 5/7		
VI				GWC-1 6.5 5/6 GWG-1 6.5 6/7	GWC-2 5.5 5/7 GWD-2 6 6/8	GWE-1 8 5/6	GWD-1 4.5 4/6	
VII				GWG-1 6.5 6/7	GWE-1 8 5/6	GWG-1 5 6/7	GWD-1 4.5 4/6	GWD-2 5 6/7
VIII					GWE-1 8 5/6 GWG-1 5 6/7		GWD-2 5 6/7 GWF-1 7 6/7	GWD-1 3.5 3/5
IX						GWD-2 5 6/7 GWF-1 7 6/7	GWG-1 4 5/6	GWD-2 4 5/7 GWE-1 5 4/5
X							GWD-2 4 5/7 GWE-1 5 4/5	GWF-1 5.5 5/6
XI							GWD-2 4 5/7	GWF-1 5.5 5/6
XII							GWF-1 5.5 5/6	
XIII							GWF-1 5.5 5/6	GWF-1 5 4/5
XIV								GWF-1 5 4/5



GORN ALLIANCE



MOVEMENT POINT RATIO TABLE: TANDEM WARP ENGINES
Movement Point Ratios

Ship Class	1/1	2/1	3/1	4/1	5/1	6/1	7/1	
II	GWA-1 25.5 7/8	GWA-1 13 6/7	GWA-1 9 5/6					
III		GWA-1 13 6/7	GWA-1 9 5/6					
IV	GWB-1 14.5 6/7	GWB-1 7 5/6	GWC-1 15.5 7/8	GWC-2 13 7/9				
V		GWB-1 7 5/6	GWB-1 11.5 5/6 GWC-1 15.5 7/8	GWC-1 11.5 6/7 GWC-2 13 7/9	GWC-2 10.5 6/8			
VI				GWC-1 11.5 6/7	GWC-1 9 5/6	GWC-2 10.5 6/8	GWC-2 8.5 5/7	
VII			GWG-1 14.5 6/8	GWD-1 11.5 6/7	GWC-1 9 5/6	GWD-1 9 5/6	GWC-2 8.5 5/7	
VIII			GWG-1 14.5 6/8	GWG-1 10.5 6/7	GWD-1 9 5/6		GWC-2 8.5 5/7 GWD-1 7.5 4.5	
IX			GWG-1 14.5 6/8	GWD-2 13 7/8	GWG-1 10.5 6/7	GWD-1 9 5/6	GWG-1 7 5/6	GWD-1 7.5 4/5
X				GWD-2 13 7/8	GWG-1 10.5 6/7	GWD-2 10.5 6/7	GWD-1 7.5 4/5	
XI				GWG-1 10.5 6/7		GWD-2 10.5 6/7 GWE-1 12.5 4/5	GWD-1 7 5/6 7.5 4/5	GWD-1 6.5 3/4
XII					GWD-2 10.5 6/7 GWE-1 12.5 4/5	GWF-1 15 6/8 GWG-1 7 5/6	GWD-2 8.5 5/7	GWD-1 6.5 3/4
XIII					GWE-1 12.5 4/5 GWF-1 15 6/8	GWG-1 7 5/6	GWD-2 8.5 5/7 GWE-1 10.5 4/5	GWF-1 12.5 6/7
XIV						GWD-2 8.5 5/7 GWE-1 10.5 4/5	GWF-1 12.5 6/7	GWF-1 10.5 5/6
XV						GWE-1 10.5 4/5	GWE-1 9 3/4	GWF-1 10.5 5/6
XVI							GWE-1 9 3/4	
XVII							GWE-1 9 3/4	



GORN ALLIANCE



Engine Type	Total Mass (mt)	Power Units Available	IMPULSE ENGINE TYPES				Availability	Cost (MCr)
			Control Computer Required	Ship Classes Powered	SS Requirement			
GIA-1	238	1	1AG	I	0.1	None	N/A	
GIA-2	238	2	1AG	I-II	0.1	None	N/A	
GIB-1	363	1	1AG	I-IV	0.1	None	N/A	
GIB-2	363	2	1AG	IV-V	0.1	None	N/A	
GIB-3	363	4	1AG	VI-VII	0.1	None	N/A	
GIC-1	650	2	1AG	V-IX	0.1	None	N/A	
GIC-2	650	3	1AG	V-XI	0.1	None	N/A	
GIC-3	650	4	1AG	V-XI	0.1	None	N/A	
GID-1	788	3	1AG	V-IX	0.1	None	N/A	
GID-2	788	6	1BG	X-XIII	0.1	None	N/A	
GID-3	788	8	1BG	XIII-XVII	0.1	None	N/A	
GIE-1	950	4	1AG	VIII-XI	0.1	None	N/A	
GIE-2	950	7	1BG	X-XIII	0.1	None	N/A	
GIE-3	950	10	1CG	XIII-XVII	0.1	None	N/A	
GIF-1	1,070	5	1BG	VIII-XII	0.1	None	N/A	
GIF-2	1,070	10	1BG	XII-XV	0.1	None	N/A	
GIF-3	1,070	15	1DG	XI-XV	0.1	None	N/A	

Ship Class	MOVEMENT POINT RATIO TABLE: IMPULSE ENGINES												
	1/2	1/1	2/1	3/1	4/1		5/1		6/1	7/1			
I	GIA-1 3 GIA-2 5.5	GIA-1 1.5 GIB-1 1.5											
II		GIA-2 3 GIB-1 1.5	GIA-2 1.5 GIB-1 0.5	GIB-1 0.5									
III		GIB-1 1.5	GIB-1 0.5	GIB-1 0.5									
IV		GIB-1 1.5	GIB-1 0.5 GIB-2 1.5	GIB-1 0.5 GIB-2 0.5		GIB-2 0.5							
V			GIB-2 1.5 GID-1 2	GIC-1 1 GID-1 1.5		GIC-1 0.5 GIC-2 1	GID-1 1	GIC-1 0.5 GIC-3 1					
VI				GIB-3 2 GIC-1 1	GID-1 1.5	GIB-3 1.5 GIC-1 0.5	GID-1 1	GIC-1 0.5 GIC-2 1	GIC-2 1	GIC-1 0.5 GIC-3 1			
VII				GIC-1 1 GID-1 1.5		GIB-3 1.5 GIC-1 0.5	GID-1 1	GIC-1 0.5 GIC-2 1	GIC-3 1 GID-1 1	GIC-1 0.5 GIC-3 1			
VIII				GIE-1 2		GIC-1 0.5 GID-1 1	GIE-1 1.5 GIF-1 2	GIC-1 0.5 GIC-2 1	GID-1 1 GIF-1 1.5	GIC-1 0.5 GIC-2 0.5 GID-1 0.5	GIC-3 1 GID-1 0.5		
IX				GIE-1 2		GIE-1 1.5 GIF-1 2		GIE-1 1 GIF-1 1.5		GIC-1 0.5 GIC-2 0.5	GID-1 0.5		
X						GID-2 2 GIE-1 1.5	GIE-2 2.5 GIF-1 2	GID-2 1.5 GIE-1 1	GIE-2 2 GIF-1 1.5	GIC-2 0.5 GID-2 1.5	GIE-2 1.5		
XI						GIE-1 1.5		GID-2 1.5 GIE-1 1 GIE-2 2	GIF-1 1.5 GIF-3 4	GID-2 1.5 GIE-2 1.5 GIF-1 1		GIC-2 0.5 GIF-1 1	
XII								GID-2 1.5 GIE-2 2	GIF-1 1.5 GIF-2 3 GIF-3 4	GID-2 1.5 GIE-2 1.5 GIF-1 1	GIF-2 2.5	GIE-2 1.5 GIF-1 1	
XIII								GID-2 1.5		GID-2 1.5 GIE-3 2.5	GIF-2 2.5 GIF-3 3.5	GID-2 1 GIE-2 1.5	
XIV										GIE-3 2.5		GID-2 1 GIE-2 1.5	GIF-2 2 GIF-3 3
XV										GIE-3 2.5		GIE-3 2 GIF-2 2	GIF-3 3
XVI												GIE-3 2	
XVII												GIE-3 2	



GORN ALLIANCE



SHIELD GENERATOR TYPES

Shield Generator Type	Total Mass (mt)	Control Computer Requirement	Shield Efficiency Rating	SS Requirement	Availability	Cost (Mcr)
GSA	165	1AG	1/2	1.0	None	N/A
GSB	210	1BG	1	1.6	None	N/A
GSC	290	1AG	1/2	2.0	None	N/A
GSD	365	1BG	1	2.2	None	N/A
GSE	460	1DG	2	2.5	None	N/A
GSF	355	1AG	1/2	2.2	None	N/A
GSG	485	1CG	1	2.8	None	N/A
GSH	595	1DG	2	3.0	None	N/A
GSI	505	1AG	1/2	2.5	None	N/A
GSJ	665	1CG	1	3.0	None	N/A
GSK	890	1EG	2	3.2	None	N/A
GSL	715	1AG	1/2	2.8	None	N/A
GSM	880	1CG	1	3.4	None	N/A
GSN	1,040	1EG	2	3.6	None	N/A

MAXIMUM SHIELD POWER Shield Types/Shield Point Ratios

Ship Class	2/1					1/1					1/2			
	GSA	GSC	GSF	GSI	GSL	GSB	GSD	GSG	GSJ	GSM	GSE	GSH	GSK	GSN
I	9 26	11 31.5	13 37	13 37	13 37	14 20	15 21.5	15 21.5	15 21.5	15 23	12 8.5	12 8.5	16 11.5	16 11.5
II	7 20	9 26	12 34.5	12 34.5	13 37	13 18.5	13 18.5	15 21.5	15 21.5	15 21.5	11 8	12 8.5	16 11.5	16 11.5
III	5 14.5	7 20	10 28.5	11 31.5	11 31.5	11 15.5	11 15.5	14 20	15 21.5	15 21.5	10 7	11 8	15 10.5	16 11.5
IV	3 8.5	5 14.5	9 26	10 28.5	9 26	10 14.5	10 14.5	14 20	15 21.5	15 21.5	10 7	10 7	15 10.5	16 11.5
V	1 3	3 8.5	8 23	9 26	9 26	9 13	10 14.5	13 18.5	14 20	15 21.5	9 6.5	10 7	14 10	15 10.5
VI	— —	2 5.5	7 20	8 23	8 23	8 11.5	9 13	12 17	14 20	15 21.5	9 6.5	10 7	14 10	15 10.5
VII	— —	1 3	5 14.5	6 17	7 20	7 10	8 11.5	11 15.5	14 20	14 20	9 6.5	10 7	13 9.5	15 10.5
VIII	— —	— —	3 8.5	5 14.5	6 17	7 10	8 11.5	10 14.5	14 20	14 20	8 5.5	9 6.5	13 9.5	14 10
IX	— —	— —	1 3	3 8.5	5 14.5	6 8.5	7 10	8 11.5	13 18.5	14 20	8 5.5	9 6.5	12 8.5	14 10
X	— —	— —	— —	1 3	3 8.5	5 7	6 8.5	8 11.5	13 18.5	14 20	7 5	7 5	12 8.5	14 10
XI	— —	— —	— —	— —	2 5.5	3 4.5	5 7	6 8.5	12 17.0	14 20	6 4.5	6 4.5	12 8.5	14 10
XII	— —	— —	— —	— —	1 3	3 4.5	5 7	6 8.5	10 14.5	13 18.5	5 3.5	5 3.5	11 8	13 9.5
XIII	— —	— —	— —	— —	— —	2 3	4 5.5	5 7	8 11.5	11 15.5	3 2	5 3.5	11 8	13 9.5
XIV	— —	— —	— —	— —	— —	1 1.5	3 4.5	3 4.5	5 7	9 13	3 2	5 3.5	10 7	13 9.5
XV	— —	— —	— —	— —	— —	— —	1 1.5	3 4.5	4 5.5	6 8.5	2 1.5	4 3	10 7	12 8.5



BLASTER WEAPON TYPES

Blaster Weapon Type	Total Mass (mt)	Maximum Beam Power	Damage Modifiers			Maximum Range (hex)	Firing Chart	Weapon Damage Factor	SS Requirement (single/bank)	Availability	Cost (MCr)
			+3	+2	+1						
GBL-1	280	4	-	-	-	10	B	0.7	0.4/0.7	None	N/A
GBL-2	300	4	-	-	-	10	G	1.1	0.6/1.1	None	N/A
GBL-3	340	3	(1-5)	(6-10)	(11-15)	15	K	2.3	1.0/1.9	None	N/A
GBL-4	400	5	(1-6)	(7-12)	(13-18)	18	P	2.8	1.4/2.7	None	N/A
GBL-5	480	4	(1-6)	(7-10)	(11-12)	14	O	3.4	1.8/3.5	None	N/A
GBL-6	600	7	(1-5)	(6-10)	(11-14)	14	M	4.5	2.2/4.0	None	N/A
GBL-7	640	5	(1-6)	(7-12)	(13-16)	16	R	4.4	2.4/4.6	None	N/A
GBL-8	680	6	(1-10)	(11-15)	(16-20)	20	W	6.5	2.8/5.3	None	N/A

MISSILE WEAPON TYPES

Missile Weapon Type	Total Mass (mt)	Power To Arm	Damage	Maximum Range (hex)	Firing Chart	Weapon Damage Factor	SS Requirement	Availability	Cost (MCr)
GP-2	400	2	10	15	K	3.0	1.2	None	N/A
GP-3	520	2	8	14	O	4.1	1.0	None	N/A
GP-4	710	2	16	14	K	6.7	1.8	None	N/A

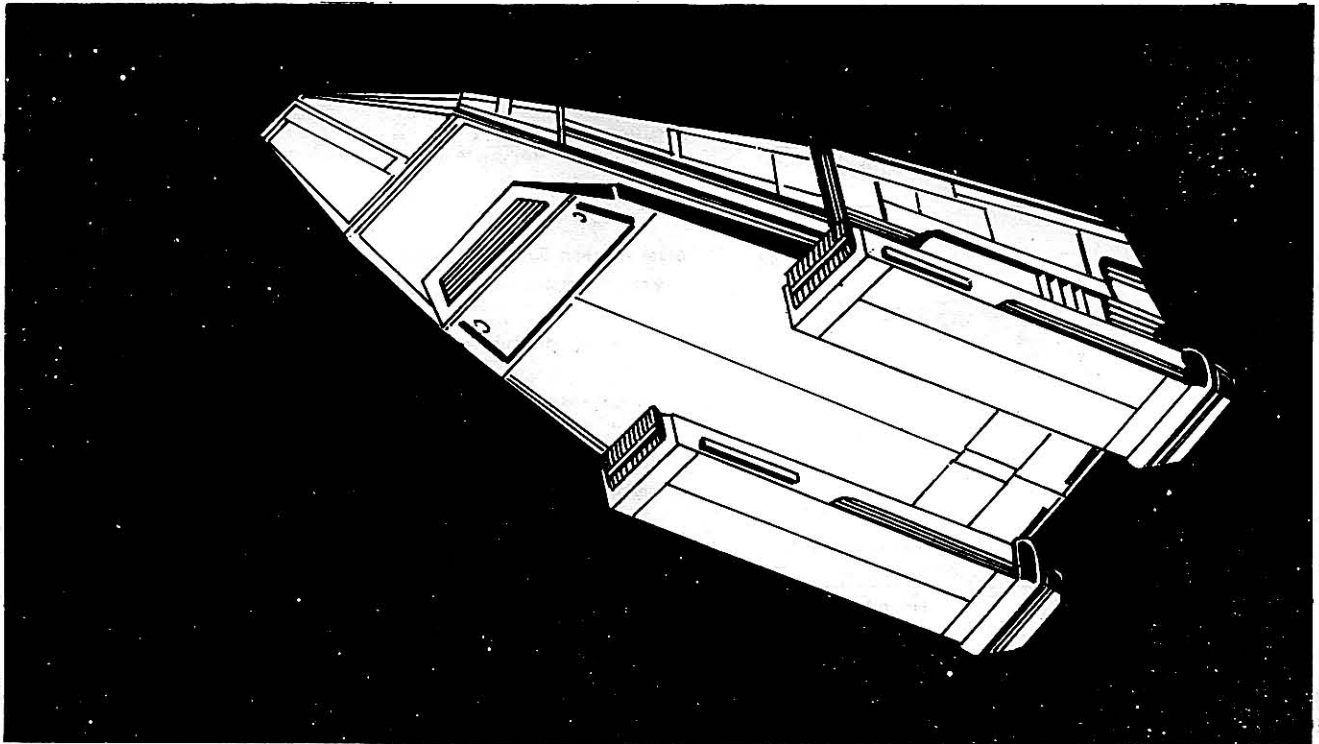

SHIP CONSTRUCTION FORM

Equipment

Class

SS

Calculations

CE

Ship Class _____
Maximum Ship Mass _____ mt

Choose Ship Class

Computer Type

Mass _____ mt
SS Requirement _____

Choose Control Computer Type

Maximum WDF _____

Warp Engine Type

Number _____
Movement Point Ratio _____
Power Units Available _____
Mass _____ mt
SS Requirement _____
Stress Columns _____
Max. Safe Cruising Speed _____
Emergency Speed _____

Choose Warp Engine Type

WER _____

Impulse Engine Type

Mass _____ mt
SS Requirement _____

Choose Impulse Engine Type

IER _____

Total Power Units Available

Calculate Total Power Units Available
Total Power Units Available = $\frac{\text{Warp Engine 1}}{\text{WER}} + \frac{\text{Warp Engine 2}}{\text{WER}} + \frac{\text{Impulse Engine}}{\text{IER}} =$ _____

Shield Generator Type

Mass _____ mt
SS Requirement _____
Shield Point Ratio _____

Choose Shield Generator Types

Calculate Power Efficiency

Power Efficiency = $(\frac{\text{WER}}{\text{WER}} + \frac{\text{IER}}{\text{IER}} + \frac{\text{DPC}}{\text{DPC}}) \times \frac{\text{SER}}{\text{SER}} =$ _____

DPC _____
SER _____
Power Efficiency _____

Beam #1 Type

Number _____
Damage Modifiers +3 (____ - ____)
+2 (____ - ____)
+1 (____ - ____)
Mass _____ mt
SS Requirement _____
Firing Chart _____
Firing Arcs _____

Choose Weapon Types

Calculate Total Weapon Mass

#1 Beam Mass = $\frac{\text{Mass}}{\text{Mass}} \times \frac{\text{Number}}{\text{Number}} =$ _____

WDF, #1 _____

#2 Beam Mass = $\frac{\text{Mass}}{\text{Mass}} \times \frac{\text{Number}}{\text{Number}} =$ _____

Missile Mass = $\frac{\text{Mass}}{\text{Mass}} \times \frac{\text{Number}}{\text{Number}} =$ _____

Beam #2 Type

Number _____
Damage Modifiers +3 (____ - ____)
+2 (____ - ____)
+1 (____ - ____)
Mass _____ mt
SS Requirement _____
Firing Chart _____
Firing Arcs _____

Calculate Weapon Superstructure

#1 Beam Superstructure = $\frac{\text{SS}}{\text{SS}} \times \frac{\text{Number}}{\text{Number}} =$ _____

WDF, #2 _____

#2 Beam Superstructure = $\frac{\text{SS}}{\text{SS}} \times \frac{\text{Number}}{\text{Number}} =$ _____

Missile Superstructure = $\frac{\text{SS}}{\text{SS}} \times \frac{\text{Number}}{\text{Number}} =$ _____

Missile Type

Number _____
Power To Arm _____
Damage _____
Mass _____ mt
SS Requirement _____
Firing Chart _____
Firing Arcs _____

Calculate Total WDF

#1 Beam WDF = $\frac{\text{WDF}}{\text{WDF}} \times \frac{\text{Number}}{\text{Number}} =$ _____

WDF, Missile _____

#2 Beam WDF = $\frac{\text{WDF}}{\text{WDF}} \times \frac{\text{Number}}{\text{Number}} =$ _____

Missile WDF = $\frac{\text{WDF}}{\text{WDF}} \times \frac{\text{Number}}{\text{Number}} =$ _____

Total WDF _____

Calculate Total SS Requirement

Warp + Impulse + Shield + Computer + #1 Beam + #2 Beam + Missile = _____

Component Mass

Total SS Required _____

SS Mass

Additional Superstructure _____

Total Ship's Mass

Total Ship's SS _____

Calculate SS Mass

SS Mass = $\frac{\text{SS}}{\text{SS}} \times 1500 = \frac{\text{SS Mass}}{\text{SS Mass}}$

Calculate Defense Factor

Defense Factor = $\frac{\text{Power Efficiency}}{\text{Power Efficiency}} + \left[\frac{\text{SS}}{\text{SS}} \times 1.43 \right] =$ _____

WDF _____
D _____
CE _____

CE = $\frac{\text{D}}{\text{D}} \times \frac{\text{WDF}}{\text{WDF}} / 100 = \frac{\text{CE}}{\text{CE}}$

SHIP CONSTRUCTION FORM

Equipment

Class

SS

Calculations

CE

Ship Class _____
Maximum Ship Mass _____ mt

Choose Ship Class

Computer Type

Mass _____ mt
SS Requirement _____

Choose Control Computer Type

Maximum WDF _____

Warp Engine Type

Number _____
Movement Point Ratio _____
Power Units Available _____
Mass _____ mt
SS Requirement _____
Stress Columns _____
Max. Safe Cruising Speed _____
Emergency Speed _____

Choose Warp Engine Type

WER _____

Impulse Engine Type

Mass _____ mt
SS Requirement _____

Choose Impulse Engine Type

IER _____

Total Power Units Available

Calculate Total Power Units Available
Total Power Units Available = $\frac{\text{Warp Engine 1}}{\text{WER}} + \frac{\text{Warp Engine 2}}{\text{WER}} + \frac{\text{Impulse Engine}}{\text{IER}} =$ _____

Shield Generator Type

Mass _____ mt
SS Requirement _____
Maximum Shield Power _____
Shield Point Ratio _____

Choose Shield Generator Types

Calculate Power Efficiency

Power Efficiency = $(\frac{\text{WER}}{\text{WER}} + \frac{\text{IER}}{\text{IER}} + \frac{\text{DPC}}{\text{DPC}}) \times \frac{\text{SER}}{\text{SER}} =$ _____

DPC _____

SER _____

Power Efficiency _____

Beam #1 Type

Number _____
Damage Modifiers +3 (____ - ____)
+2 (____ - ____)
+1 (____ - ____)
Mass _____ mt
SS Requirement _____
Firing Chart _____
Firing Arcs _____

Choose Weapon Types

Calculate Total Weapon Mass

#1 Beam Mass = $\frac{\text{Mass}}{\text{Mass}} \times \frac{\text{Number}}{\text{Number}} =$ _____

WDF, #1 _____

#2 Beam Mass = $\frac{\text{Mass}}{\text{Mass}} \times \frac{\text{Number}}{\text{Number}} =$ _____

Missile Mass = $\frac{\text{Mass}}{\text{Mass}} \times \frac{\text{Number}}{\text{Number}} =$ _____

Beam #2 Type

Number _____
Damage Modifiers +3 (____ - ____)
+2 (____ - ____)
+1 (____ - ____)
Mass _____ mt
SS Requirement _____
Firing Chart _____
Firing Arcs _____

Calculate Weapon Superstructure

#1 Beam Superstructure = $\frac{\text{SS}}{\text{SS}} \times \frac{\text{Number}}{\text{Number}} =$ _____

WDF, #2 _____

#2 Beam Superstructure = $\frac{\text{SS}}{\text{SS}} \times \frac{\text{Number}}{\text{Number}} =$ _____

Missile Superstructure = $\frac{\text{SS}}{\text{SS}} \times \frac{\text{Number}}{\text{Number}} =$ _____

Missile Type

Number _____
Power To Arm _____
Damage _____
Mass _____ mt
SS Requirement _____
Firing Chart _____
Firing Arcs _____

Calculate Total WDF

#1 Beam WDF = $\frac{\text{WDF}}{\text{WDF}} \times \frac{\text{Number}}{\text{Number}} =$ _____

WDF, Missile _____

#2 Beam WDF = $\frac{\text{WDF}}{\text{WDF}} \times \frac{\text{Number}}{\text{Number}} =$ _____

Missile WDF = $\frac{\text{WDF}}{\text{WDF}} \times \frac{\text{Number}}{\text{Number}} =$ _____

Total WDF _____

Calculate Total SS Requirement

Warp + Impulse + Shield + Computer + #1 Beam + #2 Beam + Missile = _____

Component Mass

Total SS Required _____

SS Mass

Additional Superstructure _____

Total Ship's Mass

Total Ship's SS _____

Calculate SS Mass

SS Mass = $\frac{\text{SS}}{\text{SS}} \times 1500 = \frac{\text{SS Mass}}{\text{SS Mass}}$

Calculate Defense Factor

Defense Factor = $\frac{\text{Power Efficiency}}{\text{Power Efficiency}} + \left[\frac{\text{SS}}{\text{SS}} \times 1.43 \right] =$ _____

WDF _____

D _____

CE _____

CE = $\frac{\text{D}}{\text{D}} \times \frac{\text{WDF}}{\text{WDF}} / 100 = \frac{\text{CE}}{\text{CE}}$

SHIP CONSTRUCTION FORM

Equipment

Class

SS

Calculations

CE

Ship Class _____
Maximum Ship Mass _____ mt

Choose Ship Class

Computer Type

Mass _____ mt
SS Requirement _____

Choose Control Computer Type

Maximum WDF _____

Warp Engine Type

Number _____
Movement Point Ratio _____
Power Units Available _____
Mass _____ mt
SS Requirement _____
Stress Columns _____
Max. Safe Cruising Speed _____
Emergency Speed _____

Choose Warp Engine Type

WER _____

Impulse Engine Type

Mass _____ mt
SS Requirement _____

Choose Impulse Engine Type

IER _____

Total Power Units Available

Calculate Total Power Units Available
Total Power Units Available = $\frac{\text{Warp Engine 1}}{\text{WER}} + \frac{\text{Warp Engine 2}}{\text{WER}} + \frac{\text{Impulse Engine}}{\text{IER}} =$ _____

Choose Shield Generator Types

Shield Generator Type

Mass _____ mt
SS Requirement _____
Shield Point Ratio _____

Calculate Power Efficiency

Power Efficiency = $(\frac{\text{WER}}{\text{WER}} + \frac{\text{IER}}{\text{IER}} + \frac{\text{DPC}}{\text{DPC}}) \times \frac{\text{SER}}{\text{SER}} =$ _____

DPC _____

SER _____

Power Efficiency _____

Beam #1 Type

Number _____
Damage Modifiers +3 (____ - ____)
+2 (____ - ____)
+1 (____ - ____)
Mass _____ mt
SS Requirement _____
Firing Chart _____
Firing Arcs _____

Choose Weapon Types

Calculate Total Weapon Mass

#1 Beam Mass = $\frac{\text{Mass}}{\text{Mass}} \times \frac{\text{Number}}{\text{Number}} =$ _____

WDF, #1 _____

#2 Beam Mass = $\frac{\text{Mass}}{\text{Mass}} \times \frac{\text{Number}}{\text{Number}} =$ _____

Missile Mass = $\frac{\text{Mass}}{\text{Mass}} \times \frac{\text{Number}}{\text{Number}} =$ _____

Calculate Weapon Superstructure

#1 Beam Superstructure = $\frac{\text{SS}}{\text{SS}} \times \frac{\text{Number}}{\text{Number}} =$ _____

WDF, #2 _____

#2 Beam Superstructure = $\frac{\text{SS}}{\text{SS}} \times \frac{\text{Number}}{\text{Number}} =$ _____

Missile Superstructure = $\frac{\text{SS}}{\text{SS}} \times \frac{\text{Number}}{\text{Number}} =$ _____

Calculate Total WDF

#1 Beam WDF = $\frac{\text{WDF}}{\text{WDF}} \times \frac{\text{Number}}{\text{Number}} =$ _____

WDF, Missile _____

#2 Beam WDF = $\frac{\text{WDF}}{\text{WDF}} \times \frac{\text{Number}}{\text{Number}} =$ _____

Missile WDF = $\frac{\text{WDF}}{\text{WDF}} \times \frac{\text{Number}}{\text{Number}} =$ _____

Total WDF _____

Calculate Total SS Requirement

Warp + Impulse + Shield + Computer + #1 Beam + #2 Beam + Missile = _____

Calculate SS Mass

SS Mass = $\frac{\text{SS}}{\text{SS}} \times 1500 = \frac{\text{SS Mass}}{\text{SS Mass}}$

Component Mass

Total SS Required _____

SS Mass

Additional Superstructure _____

Total Ship's Mass

Total Ship's SS _____

Calculate Defense Factor

Defense Factor = $\frac{\text{Power Efficiency}}{\text{Power Efficiency}} + \left[\frac{\text{SS}}{\text{SS}} \times 1.43 \right] =$ _____

WDF _____

D _____

CE _____

CE = $\frac{\text{D}}{\text{D}} \times \frac{\text{WDF}}{\text{WDF}} / 100 = \frac{\text{CE}}{\text{CE}}$

SHIP CONSTRUCTION FORM

Equipment

Class

SS

Calculations

CE

Ship Class _____
Maximum Ship Mass _____ mt

Choose Ship Class

Computer Type

Mass _____ mt
SS Requirement _____

Choose Control Computer Type

Maximum WDF _____

Warp Engine Type

Number _____
Movement Point Ratio _____
Power Units Available _____
Mass _____ mt
SS Requirement _____
Stress Columns _____
Max. Safe Cruising Speed _____
Emergency Speed _____

Choose Warp Engine Type

WER _____

Impulse Engine Type

Mass _____ mt
SS Requirement _____

Choose Impulse Engine Type

IER _____

Total Power Units Available

Calculate Total Power Units Available
Total Power Units Available = $\frac{\text{Warp Engine 1}}{\text{WER}} + \frac{\text{Warp Engine 2}}{\text{WER}} + \frac{\text{Impulse Engine}}{\text{IER}} =$ _____

Shield Generator Type

Mass _____ mt
SS Requirement _____
Maximum Shield Power _____
Shield Point Ratio _____

Choose Shield Generator Types

Calculate Power Efficiency

Power Efficiency = $(\frac{\text{WER}}{\text{WER}} + \frac{\text{IER}}{\text{IER}} + \frac{\text{DPC}}{\text{DPC}}) \times \frac{\text{SER}}{\text{SER}} =$ _____

DPC _____

SER _____

Power Efficiency _____

Beam #1 Type

Number _____
Damage Modifiers +3 (____ - ____)
+2 (____ - ____)
+1 (____ - ____)
Mass _____ mt
SS Requirement _____
Firing Chart _____
Firing Arcs _____

Choose Weapon Types

Calculate Total Weapon Mass

#1 Beam Mass = $\frac{\text{Mass}}{\text{Mass}} \times \frac{\text{Number}}{\text{Number}} =$ _____

WDF, #1 _____

#2 Beam Mass = $\frac{\text{Mass}}{\text{Mass}} \times \frac{\text{Number}}{\text{Number}} =$ _____

Missile Mass = $\frac{\text{Mass}}{\text{Mass}} \times \frac{\text{Number}}{\text{Number}} =$ _____

Beam #2 Type

Number _____
Damage Modifiers +3 (____ - ____)
+2 (____ - ____)
+1 (____ - ____)
Mass _____ mt
SS Requirement _____
Firing Chart _____
Firing Arcs _____

Calculate Weapon Superstructure

#1 Beam Superstructure = $\frac{\text{SS}}{\text{SS}} \times \frac{\text{Number}}{\text{Number}} =$ _____

WDF, #2 _____

#2 Beam Superstructure = $\frac{\text{SS}}{\text{SS}} \times \frac{\text{Number}}{\text{Number}} =$ _____

Missile Superstructure = $\frac{\text{SS}}{\text{SS}} \times \frac{\text{Number}}{\text{Number}} =$ _____

Missile Type

Number _____
Power To Arm _____
Damage _____
Mass _____ mt
SS Requirement _____
Firing Chart _____
Firing Arcs _____

Calculate Total WDF

#1 Beam WDF = $\frac{\text{WDF}}{\text{WDF}} \times \frac{\text{Number}}{\text{Number}} =$ _____

WDF, Missile _____

#2 Beam WDF = $\frac{\text{WDF}}{\text{WDF}} \times \frac{\text{Number}}{\text{Number}} =$ _____

Missile WDF = $\frac{\text{WDF}}{\text{WDF}} \times \frac{\text{Number}}{\text{Number}} =$ _____

Total WDF _____

Calculate Total SS Requirement

Warp + Impulse + Shield + Computer + #1 Beam + #2 Beam + Missile = _____

Component Mass

Total SS Required _____

SS Mass

Additional Superstructure _____

Total Ship's Mass

Total Ship's SS _____

Calculate SS Mass

SS Mass = $\frac{\text{SS}}{\text{SS}} \times 1500 = \frac{\text{SS Mass}}{\text{SS Mass}}$

Calculate Defense Factor

Defense Factor = $\frac{\text{Power Efficiency}}{\text{SS}} + [\frac{\text{WDF}}{\text{SS}} \times 1.43] =$ _____

WDF _____

D _____

CE _____

CE = $\frac{\text{D}}{\text{D}} \times \frac{\text{WDF}}{\text{WDF}} / 100 = \frac{\text{CE}}{\text{CE}}$

SHIP CONSTRUCTION FORM

Equipment

Class

SS

Calculations

CE

Ship Class _____
Maximum Ship Mass _____ mt

Choose Ship Class

Computer Type

Mass _____ mt
SS Requirement _____

Choose Control Computer Type

Maximum WDF _____

Warp Engine Type

Number _____
Movement Point Ratio _____
Power Units Available _____
Mass _____ mt
SS Requirement _____
Stress Columns _____
Max. Safe Cruising Speed _____
Emergency Speed _____

Choose Warp Engine Type

WER _____

Impulse Engine Type

Mass _____ mt
SS Requirement _____

Choose Impulse Engine Type

IER _____

Total Power Units Available

Calculate Total Power Units Available
Total Power Units Available = $\frac{\text{Warp Engine 1}}{\text{WER}} + \frac{\text{Warp Engine 2}}{\text{WER}} + \frac{\text{Impulse Engine}}{\text{IER}} =$ _____

Shield Generator Type

Mass _____ mt
SS Requirement _____
Maximum Shield Power _____
Shield Point Ratio _____

Choose Shield Generator Types

Calculate Power Efficiency

Power Efficiency = $(\frac{\text{WER}}{\text{WER}} + \frac{\text{IER}}{\text{IER}} + \frac{\text{DPC}}{\text{DPC}}) \times \frac{\text{SER}}{\text{SER}} =$ _____

DPC _____
SER _____
Power Efficiency _____

Beam #1 Type

Number _____
Damage Modifiers +3 (____ - ____)
+2 (____ - ____)
+1 (____ - ____)
Mass _____ mt
SS Requirement _____
Firing Chart _____
Firing Arcs _____

Choose Weapon Types

Calculate Total Weapon Mass

#1 Beam Mass = $\frac{\text{Mass}}{\text{Mass}} \times \frac{\text{Number}}{\text{Number}} =$ _____

WDF, #1 _____

#2 Beam Mass = $\frac{\text{Mass}}{\text{Mass}} \times \frac{\text{Number}}{\text{Number}} =$ _____

Missile Mass = $\frac{\text{Mass}}{\text{Mass}} \times \frac{\text{Number}}{\text{Number}} =$ _____

Beam #2 Type

Number _____
Damage Modifiers +3 (____ - ____)
+2 (____ - ____)
+1 (____ - ____)
Mass _____ mt
SS Requirement _____
Firing Chart _____
Firing Arcs _____

Calculate Weapon Superstructure

#1 Beam Superstructure = $\frac{\text{SS}}{\text{SS}} \times \frac{\text{Number}}{\text{Number}} =$ _____

WDF, #2 _____

#2 Beam Superstructure = $\frac{\text{SS}}{\text{SS}} \times \frac{\text{Number}}{\text{Number}} =$ _____

Missile Superstructure = $\frac{\text{SS}}{\text{SS}} \times \frac{\text{Number}}{\text{Number}} =$ _____

Missile Type

Number _____
Power To Arm _____
Damage _____
Mass _____ mt
SS Requirement _____
Firing Chart _____
Firing Arcs _____

Calculate Total WDF

#1 Beam WDF = $\frac{\text{WDF}}{\text{WDF}} \times \frac{\text{Number}}{\text{Number}} =$ _____

WDF, Missile _____

#2 Beam WDF = $\frac{\text{WDF}}{\text{WDF}} \times \frac{\text{Number}}{\text{Number}} =$ _____

Missile WDF = $\frac{\text{WDF}}{\text{WDF}} \times \frac{\text{Number}}{\text{Number}} =$ _____

Total WDF _____

Calculate Total SS Requirement

Warp + Impulse + Shield + Computer + #1 Beam + #2 Beam + Missile = _____

Component Mass

Total SS Required _____

SS Mass

Additional Superstructure _____

Total Ship's Mass

Total Ship's SS _____

Calculate SS Mass

SS Mass = $\frac{\text{SS}}{\text{SS}} \times 1500 = \frac{\text{SS Mass}}{\text{SS Mass}}$

Calculate Defense Factor

Defense Factor = $\frac{\text{Power Efficiency}}{\text{Power Efficiency}} + \left[\frac{\text{SS}}{\text{SS}} \times 1.43 \right] =$ _____

WDF _____
D _____
CE _____

CE = $\frac{\text{D}}{\text{D}} \times \frac{\text{WDF}}{\text{WDF}} / 100 = \frac{\text{CE}}{\text{CE}}$

Begin your career as a starship engineer.

The **Ship Construction Manual** contains all of the information necessary to construct starships for your **STAR TREK Role Playing Games**. The recently declassified information in this manual allows the design of state-of-the-art starships of Federation, Klingon, Romulan, Gorn, or Orion origin. The easy-to-use format combined with the comprehensive data also provides the information necessary to build any ship active during the last 60 years of *Star Trek* history.

The 80-page rulebook includes the tables for the various engines, weapons, shields, and computers that make up starships, essays on the design philosophy of the major races, detailed information on the cost and availability of the equipment, and a system for rating the ships in combat.

The **Ship Construction Manual** is required reading for all Star Fleet personnel and potential ship designers from all of the major races.

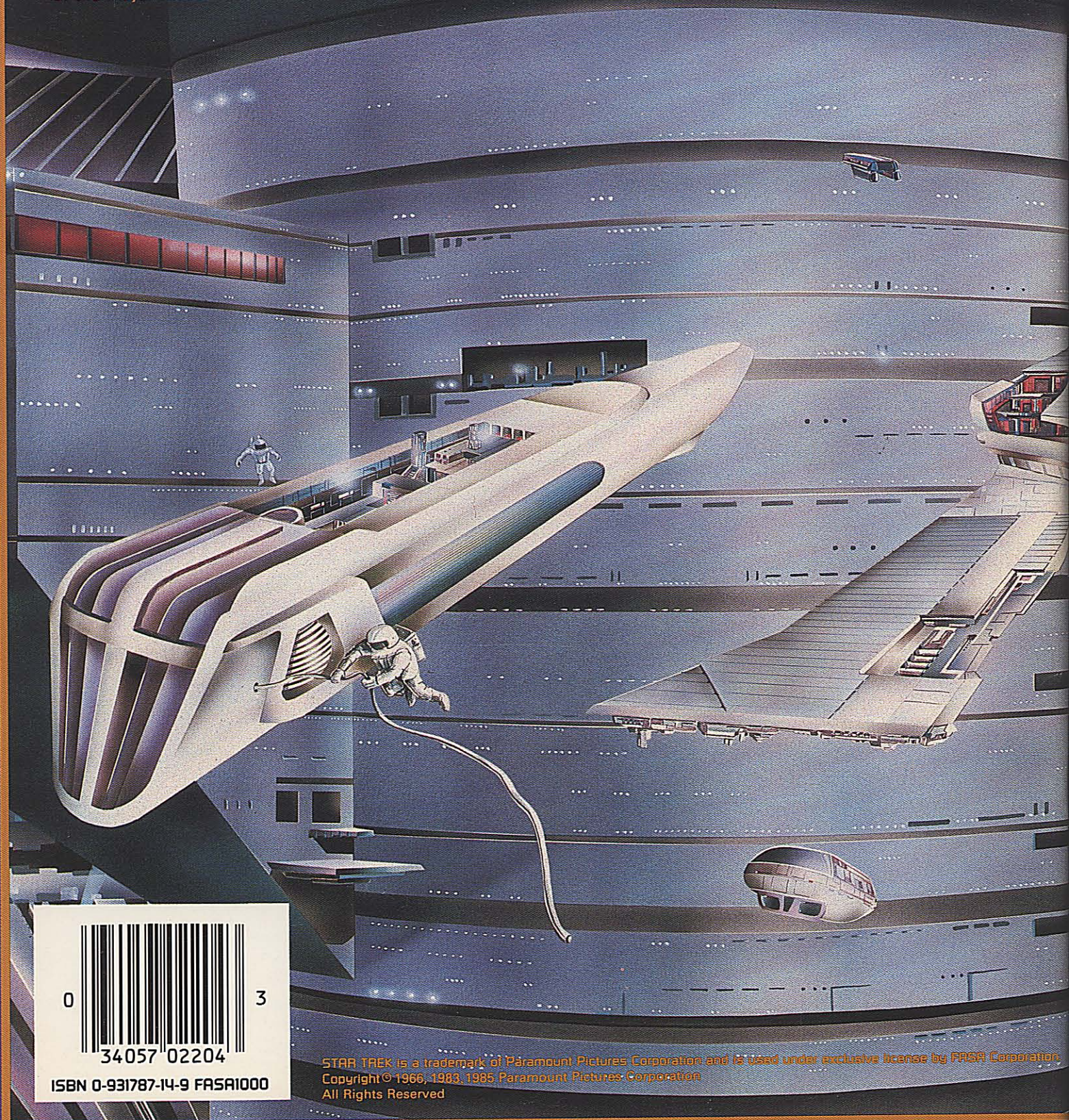

0



3

34057 02204

ISBN 0-931787-14-9 FASA1000

STAR TREK is a trademark of Paramount Pictures Corporation and is used under exclusive license by FASA Corporation.
Copyright © 1966, 1983, 1985 Paramount Pictures Corporation
All Rights Reserved